

# User Manual

## MEGA-3110 Series

High-Performance GPU Computer  
with Intel® 9th / 8th LGA1151 Processors

# Record of Revisions

Version	Issue Date	Descriptions	Made By
1.0	2021/10/18	First Release	Jerry

## Copyright

The documentation and the software included with this product are copyrighted by Arestech Cooperation Co., Ltd. All rights are reserved. No part of this manual may be reproduced, copied, translated, or transmitted in any form or by any means without the prior written permission of Arestech Cooperation Co., Ltd. Information provided in this manual is intended to be accurate and reliable.

## Trademark Acknowledgement

Brand and product names are registered trademarks of their respective owners.

## Disclaimer

Arestech reserves the right to make changes, without notice, to any product described or contained in this manual to improve design and/or performance. Applications that are described in this manual are for illustration purposes only. Arestech makes no representation or guarantee that such application will be suitable for the specified use without further testing or modification. This manual might include unintentional typographical or technical errors. Arestech will periodically correct such erroneous files and incorporate these corrections into the new version of the manual.

## Technical Support and Assistance

If there is a problem with your product and you are unable to get a solution from the user's manual, please contact the local distributor.

## Product Warranty (2 Years)

Arestech warrants to you, the original purchaser, that each of its products will be free from defects in materials and workmanship for two years from the invoice date. This warranty does not apply to any products which have been repaired or altered by persons other than repair personnel authorized by Arestech, or which have been subject to misuse, abuse, accident, or improper installation. Arestech assumes no liability under the terms of this warranty as a consequence of such events. When a defect is discovered, please obtain an RMA (return merchandise authorization) from our website, which allows us to process your return more quickly. The returned product must be properly packaged in its original packaging to obtain warranty service.

# Safety Instructions

1. Read these safety instructions carefully.
2. Keep this User Manual for later reference.
3. Disconnect this equipment from any AC outlet before cleaning. Use a damp cloth. Do not use liquid or spray detergents for cleaning.
4. For plug-in equipment, the power outlet socket must be located near the equipment and must be easily accessible.
5. Keep this equipment away from humidity.
6. Put this equipment on a reliable surface during installation. Dropping it or letting it fall may cause damage.
7. The openings on the enclosure are for air convection. Protect the equipment from overheating. **DO NOT COVER THE OPENINGS.**
8. Make sure the voltage of the power source is correct before connecting the equipment to the power outlet.
9. Position the power cord so that people cannot step on it. Do not place anything over the power cord.
10. All cautions and warnings on the equipment should be noted.
11. If the equipment is not used for a long time, disconnect it from the power source to avoid damage by transient overvoltage.
12. Never pour any liquid into an opening. This may cause fire or electrical shock.
13. For safety reasons, the equipment should be opened only by qualified service personnel. If one of the following situations arises, get the equipment checked by service personnel:
  - The power cord or plug is damaged.
  - Liquid has penetrated into the equipment.
  - The equipment has been exposed to moisture.
  - The equipment does not work well, or you cannot get it to work according to the user manual.
  - The equipment has been dropped and damaged.
  - The equipment has obvious signs of breakage.
14. **DO NOT LEAVE THIS EQUIPMENT IN AN ENVIRONMENT WHERE THE STORAGE TEMPERATURE MAY GO BELOW -20° C (-4° F) OR ABOVE 55° C (131° F). THIS COULD DAMAGE THE EQUIPMENT. THE EQUIPMENT SHOULD BE IN A CONTROLLED ENVIRONMENT.**
15. **CAUTION: DANGER OF EXPLOSION IF BATTERY IS INCORRECTLY REPLACED. REPLACE ONLY WITH THE SAME OR EQUIVALENT TYPE RECOMMENDED BY THE MANUFACTURER, DISCARD USED BATTERIES ACCORDING TO THE MANUFACTURER'S INSTRUCTIONS.**

## Safety Precaution - Static Electricity

Follow these simple precautions to protect yourself from harm and the products from damage:

1. To avoid electrical shock, always disconnect the power from your PC chassis before you work on it. Don't touch any components on the CPU card or other cards while the PC is on.
2. Disconnect power before making any configuration changes. The sudden rush of power as you connect a jumper or install a card may damage sensitive electronic components.

# Contents

<b>Chapter 1. Product Introductions .....</b>	<b>8</b>
1.1 Overview .....	8
1.2 MEGA-3110 Series Specifications .....	9
1.3 Panel I/O .....	11
1.3.1 Front Panel.....	11
1.3.2 Top Panel .....	13
1.4 Mechanical Dimensions.....	15
1.4.1 MEGA-3112.....	15
1.4.2 MEGA-3113.....	16
<b>Chapter 2. Switches and Connectors .....</b>	<b>18</b>
2.1 Switches and Connectors .....	18
2.1.1 Front View .....	18
2.1.2 Top View .....	18
2.2 Switches, LEDs and Connectors Definitions .....	19
2.3 Switch Definitions .....	20
2.4 Connector Definitions.....	23
<b>Chapter 3. System Setup .....</b>	<b>32</b>
3.1 Removing CPU Heat Sink Cover .....	32
3.2 Installing CPU .....	33
3.3 Installing A SODIMM.....	38
3.4 Installing A Mini-PCIe or mSATA Module .....	40
3.5 Installing An Antenna .....	41
3.6 Installing A Removable SATA HDD Bay .....	43
3.7 Installing An Internal SATA HDD Bay .....	44
3.8 Installing A CFast1/2 or SIM1/2 Card .....	47
3.9 Installing An Internal SIM3/4 Card .....	48
3.10 Changing A CMOS Battery .....	50
3.11 Assembly the CPU Heat Sink Cover .....	51
3.12 Installing A PCIe Expansion Card .....	52

3.13	Connecting The Expansion Module with The PC Module .....	55
3.14	Installing A Stand / Wall Mount .....	56
<b>Chapter 4. BIOS Setup .....</b>		<b>57</b>
4.1	BIOS Introduction .....	57
4.2	Main Setup.....	58
4.3	Advanced Setup .....	59
4.3.1	CPU Configuration .....	59
4.3.2	PCH-FW Configuration.....	60
4.3.3	SATA & RST Configuration .....	61
4.3.4	Trusted Computing.....	62
4.3.5	ACPI Settings.....	64
4.3.6	Super IO Configuration .....	65
4.3.7	Serial Port Console Redirection .....	69
4.3.8	Hardware Monitor .....	71
4.3.9	USB Configuration .....	72
4.3.10	CSM Configuration.....	73
4.4	Chipset .....	75
4.4.1	System Agent (SA) Configuration .....	75
4.4.2	PCH-IO Configuration .....	78
4.5	Security .....	81
4.6	Boot	82
4.7	Save & Exit .....	83

# Chapter 1. Product Introductions

## 1.1 Overview

MEGA-3110 series is a high-spec GPU system equipped with convertible expansion module technology (CEM technology). It supports PCIe modular expansion functions and can be used with nVIDIA RTX-2080 or higher GPU graphics cards or accelerator cards. It can reduce CPU loading and increase the speed and ability of image processing.

What's more, MEGA-3110 series uses Intel® 9th/8th CFL-R/S platform, which can support up to octa-core processors. The configuration of 4x SATA and 2x CFast/ mSATA in the system is more suitable for the storage and backup of large amounts of data. This series is ideal for image recognition, security monitoring, unmanned intelligent vehicles, factory automation, machine vision, and other fields.



## 1.2 MEGA-3110 Series Specifications

### Processor

Support 9th/ 8th Intel® Core™ i3 / i5 / i7 Desktop 35W/ 65W LGA 1151 Processors

- Intel® Core™ i7-9700TE, Octa Core, 12M Cache, up to 3.8 GHz, 35W TDP
- Intel® Core™ i7-9700E, Octa Core, 12M Cache, up to 4.4 GHz, 65W TDP
- Intel® Core™ i5-9500TE, Hexa Core, 12M Cache, up to 3.6 GHz, 35W TDP
- Intel® Core™ i5-9500E, Hexa Core, 12M Cache, up to 4.2 GHz, 65W TDP
- Intel® Core™ i3-9100TE, Quad Core, 6M Cache, 3.3 GHz, 35W TDP
- Intel® Core™ i3-9100E, Quad Core, 6M Cache, 3.7 GHz, 65W TDP
- Intel® Core™ i7-8700T, Hexa Core, 12M Cache, up to 4.0 GHz, 35W TDP
- Intel® Core™ i7-8700, Hexa Core, 12M Cache, up to 4.6 GHz, 65W TDP
- Intel® Core™ i5-8500T, Hexa Core, 9M Cache, up to 3.5 GHz, 35W TDP
- Intel® Core™ i5-8500, Hexa Core, 9M Cache, up to 4.1 GHz, 65W TDP
- Intel® Core™ i3-8100T, Quad Core, 6M Cache, 3.1 GHz, 35W TDP
- Intel® Core™ i3-8100, Quad Core, 6M Cache, up to 3.6 GHz, 65W TDP

### BIOS

- AMI BIOS, 256Mbit SPI Flash ROM on board.

### Chipset

- Intel® Q370 Express Chipset

### Memory

- 2x DDR4-2400/2666MHz 260-Pin SO-DIMM Socket
- Support up to 64GB (un-buffered and non-ECC)

### Graphics

- Integrated Intel® UHD Graphics 630 (Core™ i7/ i5/ i3)
- Integrated Intel® UHD Graphics 610 (Pentium/ Celeron)
- Supports Triple Independent Display
- 1x VGA
- 1x DVI-D
- 1x DisplayPort

### Audio

- Realtek ALC888S
- High Definition Audio

### Ethernet

- GbE1: Intel® i219-LM (Support Wake-on-LAN and PX)
- GbE2~GbE3: Intel® i210-AT GbE (Support Wake-on-LAN and PXE)

### Watchdog Timer

- Software Programmable Supports 1~255 sec. System Reset

### I/O Ports

- 1x VGA
- 1x DVI-D
- 1x DisplayPort
- 3x GbE RJ45
- 6x USB 3.1 Port
- 2x Internal USB 2.0 Port
- 6x RS232/422/485 with Auto Flow Control, DB9
- 1x Line-out and 1x Mic-in, Phone Jack 3.5mm
- 8x Isolated DI and 8x Isolated DO Port, 2x9-Pin Terminal Block
- 1x Power On/Off Button
- 1x AT/ATX Mode Switch
- 1x PC/Car Mode Switch
- 1x Removable CMOS Battery
- 1x External Clear CMOS Switch
- 1x Remote Power on/off Connector, 2-Pin Terminal Block
- 2x Flexible I/O Window Slot

**Expansion**

- MEGA-3112: 1x PCIe X16 and 1x PCIe X4 Slot
- MEGA-3113: 1x PCIe X16 and 2x PCIe X4 Slot
- 2x Full-size Mini-PCIe Socket (mux with mSATA)
- 2x Full-size Mini-PCIe Socket
- 4x SIM Socket
- 8x Antenna Hole

**Storage**

- 2x Removable 2.5" SATA HDD Bay
- 2x Internal 2.5" SATA HDD Bay
- 2x CFast Socket (Shared by 2x mSATA)
- 2x mSATA Socket (Shared by 2x Mini-PCIe and Cfast)

**Power Requirement**

- Support Hardware AT, ATX Power Mode
- 2x3-pin Terminal Block Connector with Power Input 9~48VDC (without GPU Card)
- 2x3-pin Terminal Block Connector with Power Input 24~48VDC (with GPU Card)
- Power Ignition Sensing
- 1x Optional AC/DC 24V/21A, 500W Power Supply
- 1x Optional AC/DC 48V/21A, 1008W Power Supply

**Protection**

- Over Voltage Protection (OVP) Up to 52V
- Reverse Voltage Protection (RVP) up to -48V
- Over Current Protection (OCP) 20A

**Environment**

- Operating Temperature (Ambient with Air Flow):  
-40°C to 70°C (without GPU Card)  
-40°C to 60°C (with GPU Card)
- Storage Temperature: -40°C to 80°C
- Relative humidity: 10%~95% (non-condensing)
- Shock: 30 Grms, Half-sine 11 ms
- Vibration: 3 Grms, 5-500 Hz, 3 Axis

**Physical**

- **MEGA-3112**  
Dimension (WxDxH): 148 x 356 x 241.5 mm
- **MEGA-3113**  
Dimension (WxDxH): 168 x 356 x 241.5 mm  
Extruded Aluminum with Heavy Duty Metal
- Wall mounting
- Stand mounting

## 1.3 Panel I/O

### 1.3.1 Front Panel

- **Power On/Off Button**  
Press to turn on or off the system
- **AT/ATX Mode Select Switch**  
Used to select AT or ATX power mode
- **Reset Button**  
Used to reset the system
- **COM Port**  
COM1 ~ COM2 support RS232/422/485 serial device
- **LAN Port**  
Used to connect the system to a local area network
- **USB 3.0 Port**  
Used to connect a USB 3.0 device
- **DisplayPort**  
Used to connect a DisplayPort monitor
- **DVI-D Port**  
Used to connect a DVI monitor
- **VGA Port**  
Used to connect a VGA monitor
- **Line-out**  
Used to connect a speaker
- **Mic-in**  
Used to connect a microphone
- **Remote Power On/Off Terminal Block**  
Used to plug in a remote power on/off terminal block
- **DC IN**  
Used to plug in a DC power input with terminal block
- **Earthing Screw Hole**  
Used to connect the ground wire
- **Antenna Hole**  
Used to connect an antenna for optional Mini-PCIe Wi-Fi module
- **Removable HDD Port**  
Removable 2.5" SATA HDD Area
- **Expansion Slot**  
Used to plug in a PCI or PCIe card.
- **Power LED**  
Indicates the power status of the system
- **IGN LED**  
Indicates the status of the active ignition
- **GPIO LED**  
Indicates the status of the GPIO defined by customer

MEGA-3112

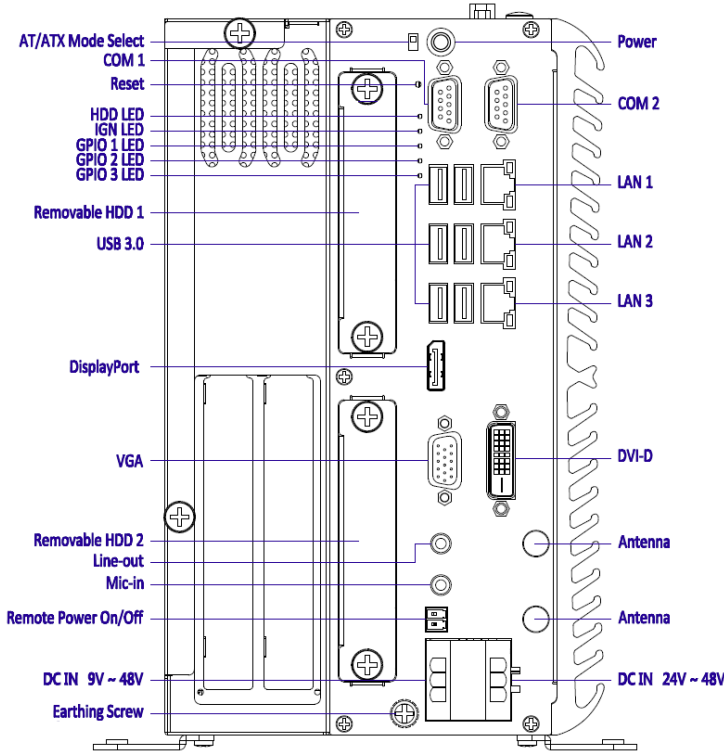

MEGA-3113

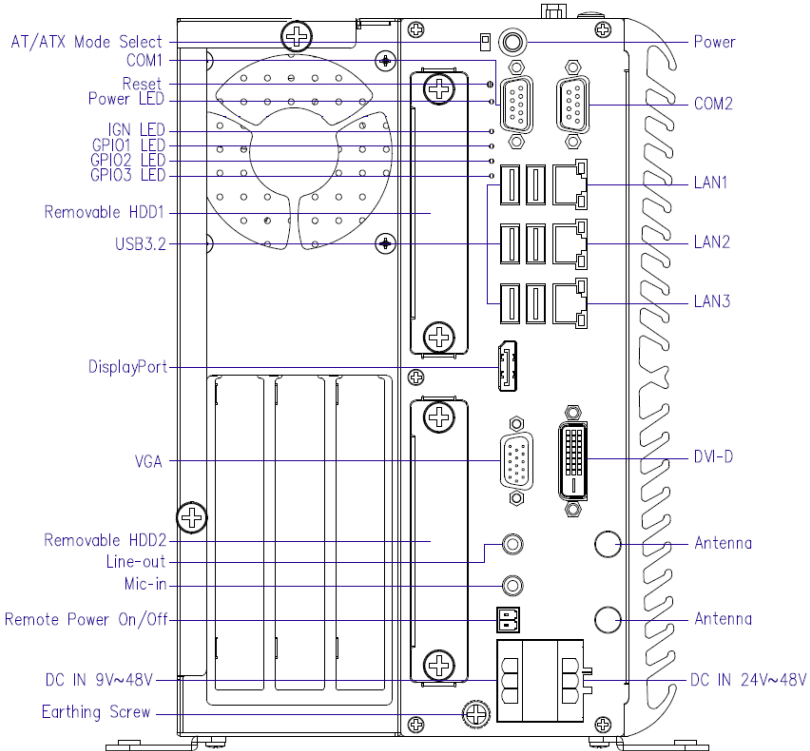

## 1.3.2 Top Panel

- **Clear CMOS**  
Used to clear CMOS
- **PC/Car Mode Select Switch**  
Used to select PC or Car mode
- **Delay Time Select Switch**  
Used to select car mode system to turn off delay time
- **CMOS Battery**  
Used to change a CMOS battery
- **SIM Card**  
Used to insert a SIM card
- **CFast Socket**  
Used to insert a CFast card
- **COM Port**  
COM1 ~ COM2 support RS232/422/485 serial device
- **Digital I/O Terminal Block**  
Supports 8 digital inputs and 8 digital outputs
- **Antenna Hole**  
Used to connect an antenna for optional Mini-PCIe WiFi module
- **Flexible I/O Window Slot**  
Used to customize I/O output

### MEGA-3112

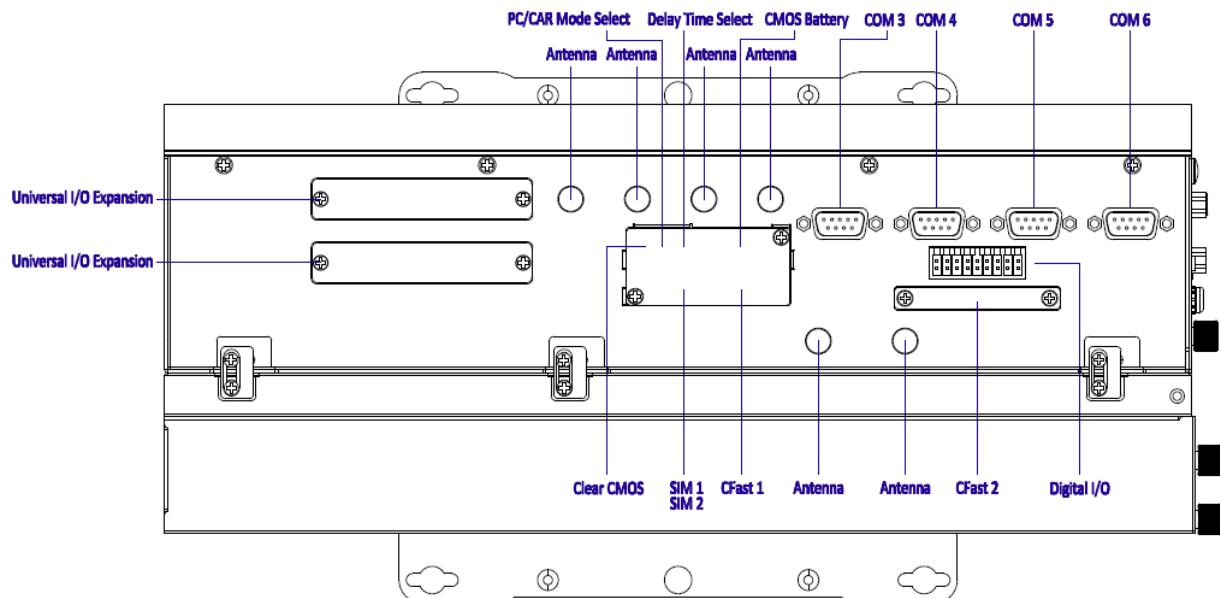

MEGA-3113

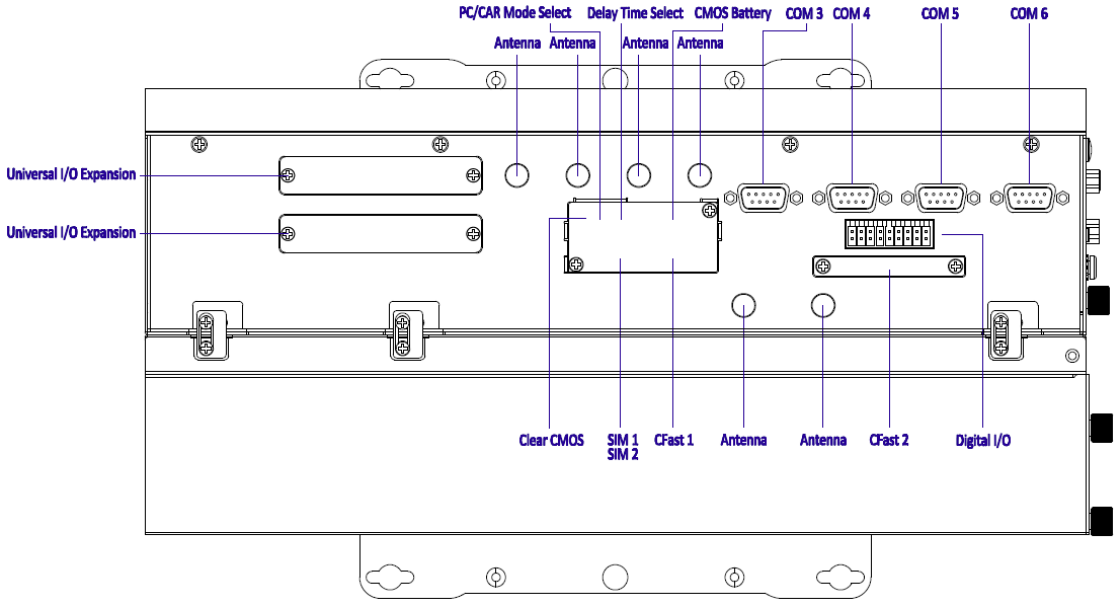

# 1.4 Mechanical Dimensions

## 1.4.1 MEGA-3112

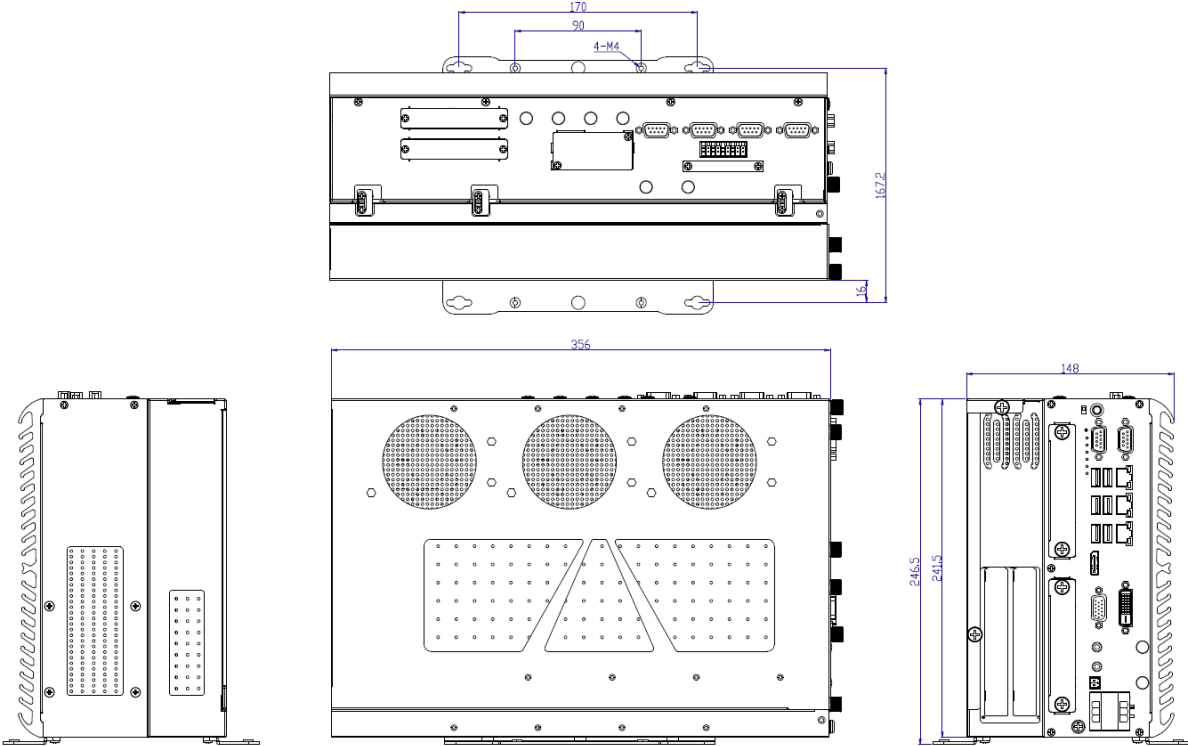

# 1.4.2 MEGA-3113

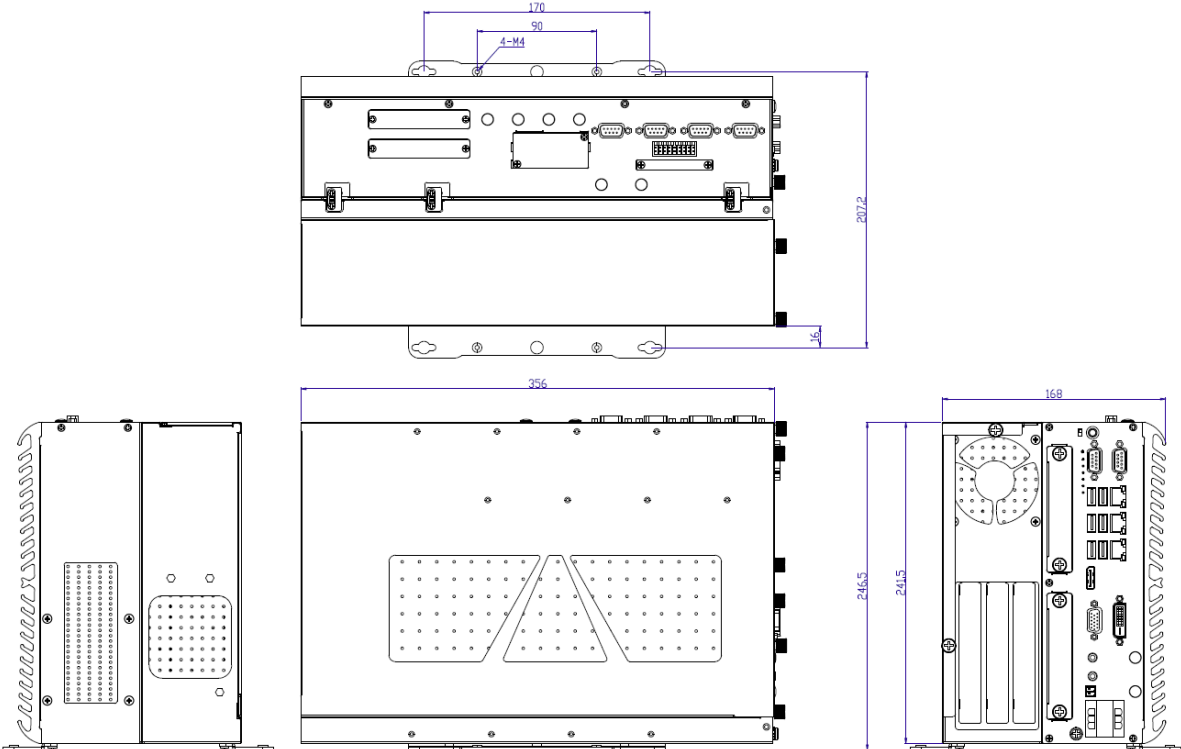





# Chapter 2. Switches and Connectors

## 2.1 Switches and Connectors

### 2.1.1 Front View

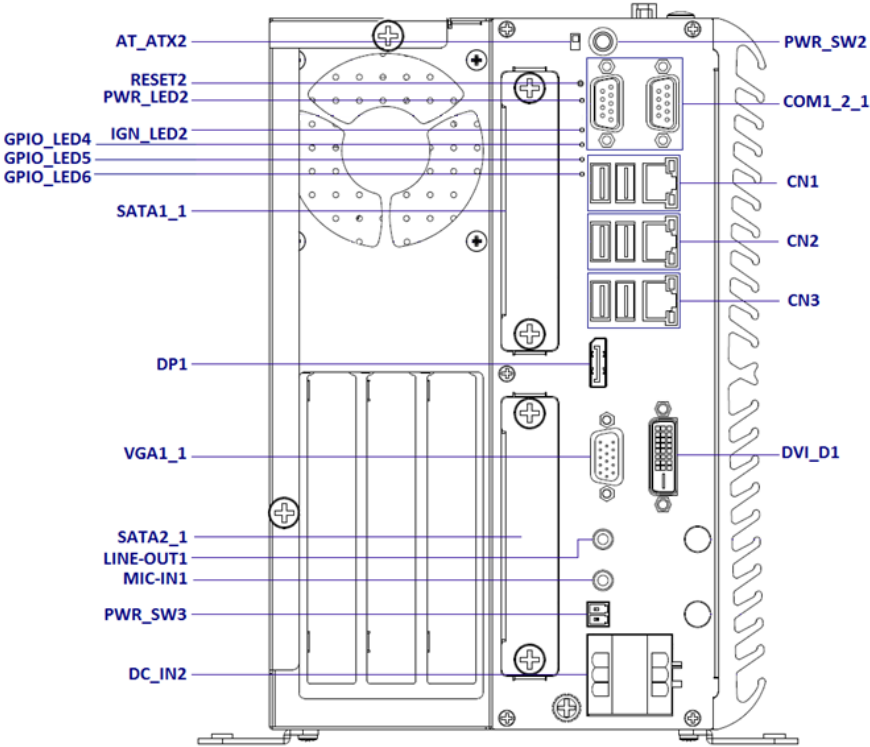

### 2.1.2 Top View

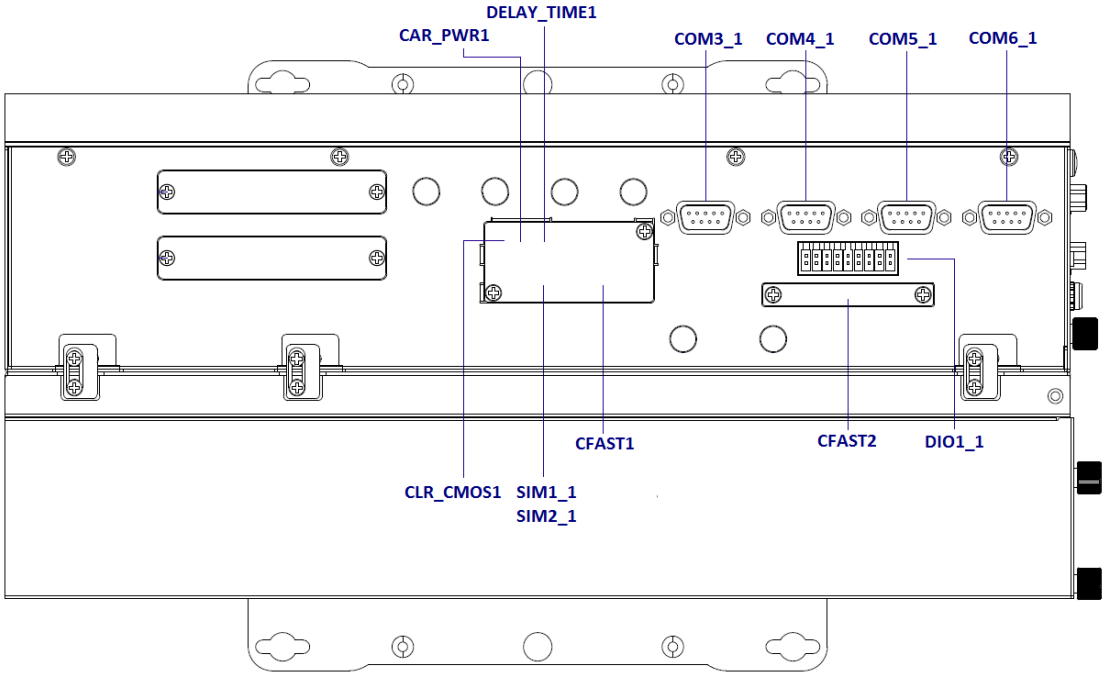

## 2.2 Switches, LEDs and Connectors Definitions

### ■ List of Switches and LEDs

Location	Definition
PWR_SW2	Power Button
AT_ATX2	AT / ATX Power Mode Switch
RESET2	Reset Button
CLR_CMOS1	Clear BIOS Switch
CAR_PWR1	PC / Car Mode Switch
DELAY_TIME1	Car mode system turn off delay time
PWR_LED2	Power LED Status
IGN_LED2	Power Ignition LED Status
GPIO_LED4, GPIO_LED5, GPIO_LED6	GPIO LED Status

### ■ List of Connectors

Location	Definition
PWR_SW3	Remote Power On/Off Connector
USB7_1, USB8_1	USB 2.0 Port
COM1_2_1	RS232 / RS422 / RS485 Connector
COM3_1, COM4_1, COM5_1, COM6_1	RS232 / RS422 / RS485 Connector
CFAST1, CFAST2	CFast Socket
DC_IN2	6-pin DC 24~48V Power Input with Power Ignition Connector
SIM1_1, SIM2_1, SIM3_1, SIM4_1	SIM Card Socket
LINE_OUT1	Line-out Jack
MIC_IN1	Mic-in Jack
POWER1, POWER2	Power Connector
DIO1_1	8DI / 8DO Connector
VGA1_1	VGA Connector
DVI_D1	DVI-D Connector
DP1	DisplayPort Connector
SODIMM1, SODIMM2	DDR3L SODIMM Socket
CN1, CN2, CN3	LAN and USB3.0 Port
MINIPICIE1, MINIPICIE2	Mini PCI-Express Socket
CN4, CN5	Dual Mode Mini PCI-Express / mSATA Socket
SATA1_1, SATA2_1, SATA3_1, SATA4_1	22-pin SATA with Power Connector
FAN1	Internal PWM FAN Connector

## 2.3 Switch Definitions

### ■ PWR\_SW2: Power Button

Switch	Definition
Push	Power On/Off System



### ■ AT\_ATX2: AT / ATX Power Mode Switch

Pin	Definition
1-2 (Right)	ATX Power Mode (Default)
2-3 (Left)	AT Power Mode



### ■ RESET2: Reset Button

Switch	Definition
Push	Reset System



### ■ CLR\_CMOS1: CMOS Clear Switch

Pin	Definition
1-2 (Left)	Normal (Default)
2-3 (Right)	Clear CMOS



### ■ CAR\_PWR1: PC / Car Mode Switch

Pin	Definition
1-2 (Left)	PC Power Mode (Default)
2-3 (Right)	Vehicle Power Ignition Mode



■ **DELAY\_TIME1: Switch to Car Mode to Turn off Delay Time**

Switch 1 / 2 / 3	Definition
ON / ON / ON	Shutdown Timer by O.S (Default)
ON / ON / OFF	1 min.
ON / OFF / ON	5 mins.
ON / OFF / OFF	10 mins.
OFF / ON / ON	30 mins.
OFF / ON / OFF	1 hour
OFF / OFF / ON	2 hours
OFF / OFF / OFF	Reserved



■ **Steps to Set the Power Ignition**

Step 1: Select the power ignition by PC/CAR switch.



Step 1  
 Pin 1-2 (Left) : PC Power Mode  
 Pin 2-3 (Right) : Vehicle Power Ignition Mode

Step 2: To configure the power off delay time, please check the delay time setting options in advance.



Switch 1 / 2 / 3	Definition
ON / ON / ON	Shutdown Timer by O.S (Default)
ON / ON / OFF	1 min.
ON / OFF / ON	5 mins.
ON / OFF / OFF	10 mins.
OFF / ON / ON	30 mins.
OFF / ON / OFF	1 hour
OFF / OFF / ON	2 hours

Example: Set the delay time as 1 minute

When the delay time is set as “1 minute”, the system will shut down 1 minute after you turn off the vehicle engine.



Step 3: Connect the vehicle battery and ignition signal

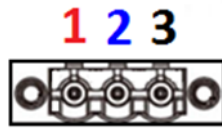
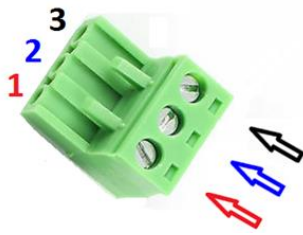

Pin	Definition
1	+9~48VIN
2	Power Ignition
3	GND

■ PWR\_LED2: Power Status LED

Power Status	LED Color
Power ON	Blue



■ IGN\_LED2 : Ignition Status LED

IGN Status	LED Color
IGN ON	Green



■ GPIO\_LED4 : GPIO Status LED

GPIO Status	LED Color
GPIO ON	Red



■ GPIO\_LED5 : GPIO Status LED

GPIO Status	LED Color
GPIO ON	Red



■ GPIO\_LED6 : GPIO Status LED

GPIO Status	LED Color
GPIO ON	Red



## 2.4 Connector Definitions

### ■ PWR\_SW3 : Remote Power Switch

Connector Type : Terminal Block 1X2 2-pin, 3.5mm pitch

Pin	Definition
1	Power Button
2	GND

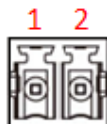

### ■ COM1\_2\_1 : RS232 / RS422 / RS485 Connector

Connector Type : 9-pin D-Sub

Pin	RS232 Definition	RS422 / 485 Full Duplex Definition	RS485 Half Duplex Definition
1	DCD1	TX1-	DATA1-
2	RxD1	TX1+	DATA1+
3	TxD1	RX1+	
4	DTR1	RX1-	
5	GND		
6	DSR1		
7	RTS1		
8	CTS1		
9	RI1		

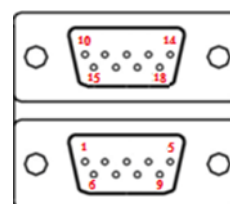

Pin	RS232 Definition	RS422 / 485 Full Duplex Definition	RS485 Half Duplex Definition
10	DCD2	TX2-	DATA2-
11	RxD2	TX2+	DATA2+
12	TxD2	RX2+	
13	DTR	RX2-	
14	GND		
15	DSR2		
16	RTS2		
17	CTS2		
18	RI2		

### ■ COM3\_1 : RS232 / RS422 / RS485 Connector

Connector Type : 9-pin D-Sub

Pin	RS232 Definition	RS422 / 485 Full Duplex Definition	RS485 Half Duplex Definition
1	DCD3	TX3-	DATA3-
2	RxD3	TX3+	DATA3+
3	TxD3	RX3+	
4	DTR	RX3-	
5	GND		
6	DSR3		
7	RTS3		
8	CTS3		
9	RI3		

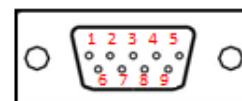

### ■ COM4\_1 : RS232 / RS422 / RS485 Connector

Connector Type : 9-pin D-Sub

Pin	RS232 Definition	RS422 / 485 Full Duplex Definition	RS485 Half Duplex Definition
1	DCD4	TX4-	DATA4-
2	RxD4	TX4+	DATA4+
3	TxD4	RX4+	
4	DTR	RX4-	
5	GND		
6	DSR4		
7	RTS4		
8	CTS4		
9	RI4		

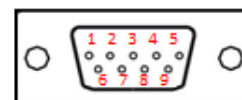



■ COM5\_1 : RS232 / RS422 / RS485 Connector

Connector Type : 9-pin D-Sub

Pin	RS232 Definition	RS422 / 485 Full Duplex Definition	RS485 Half Duplex Definition
1	DCD5	TX5-	DATA5-
2	RxD5	TX5+	DATA5+
3	TxD5	RX5+	
4	DTR	RX5-	
5	GND		
6	DSR5		
7	RTS5		
8	CTS5		
9	RI5		

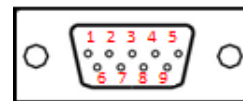

■ COM6\_1 : RS232 / RS422 / RS485 Connector

Connector Type : 9-pin D-Sub

Pin	RS232 Definition	RS422 / 485 Full Duplex Definition	RS485 Half Duplex Definition
1	DCD6	TX6-	DATA6-
2	RxD6	TX6+	DATA6+
3	TxD6	RX6+	
4	DTR	RX6-	
5	GND		
6	DSR6		
7	RTS6		
8	CTS6		
9	RI6		

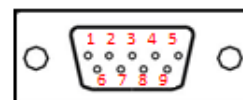

■ **DC\_IN2 : DC Power Input Connector (+24~48V)**

Connector Type: Terminal Block 2X3 3-pin, 5.0mm pitch

Pin	Definition
1	+24~48VIN
2	+24~48VIN
3	Power Ignition
4	Power Ignition
5	GND
6	GND

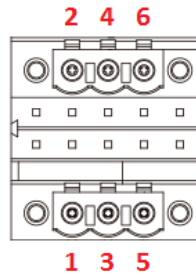

■ **POWER1, POWER2 : Power Connector**

Connector Type : 1X4-pin Wafer, 2.0mm pitch

Pin	Definition
1	+5V
2	GND
3	GND
4	+12V

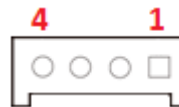

■ **DIO1\_1 : Digital Input / Output Connector**

Connector Type : Terminal Block 2X5 18-pin, 3.5mm pitch

Pin	Definition	Pin	Definition
1	External DC Voltage Input	2	External GND
3	DI1	4	DO1
5	DI2	6	DO2
7	DI3	8	DO3
9	DI4	10	DO4
11	DI5	12	DO5
13	DI6	14	DO6
15	DI7	16	DO7
17	DI8	18	DO8



Reference Input Circuit

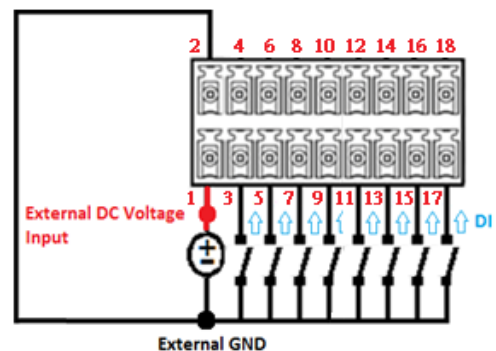
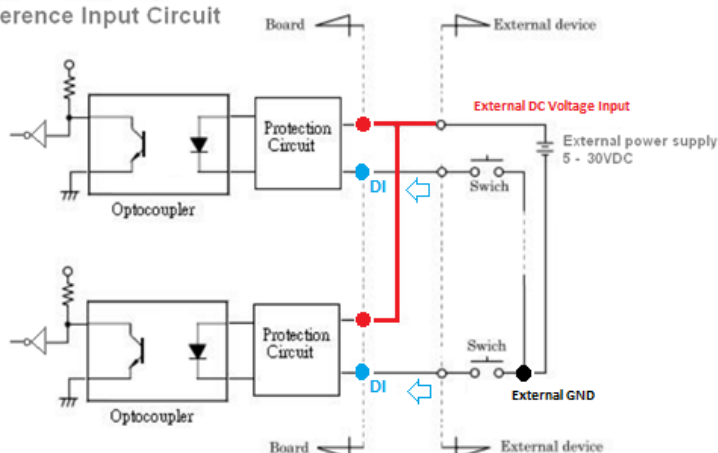

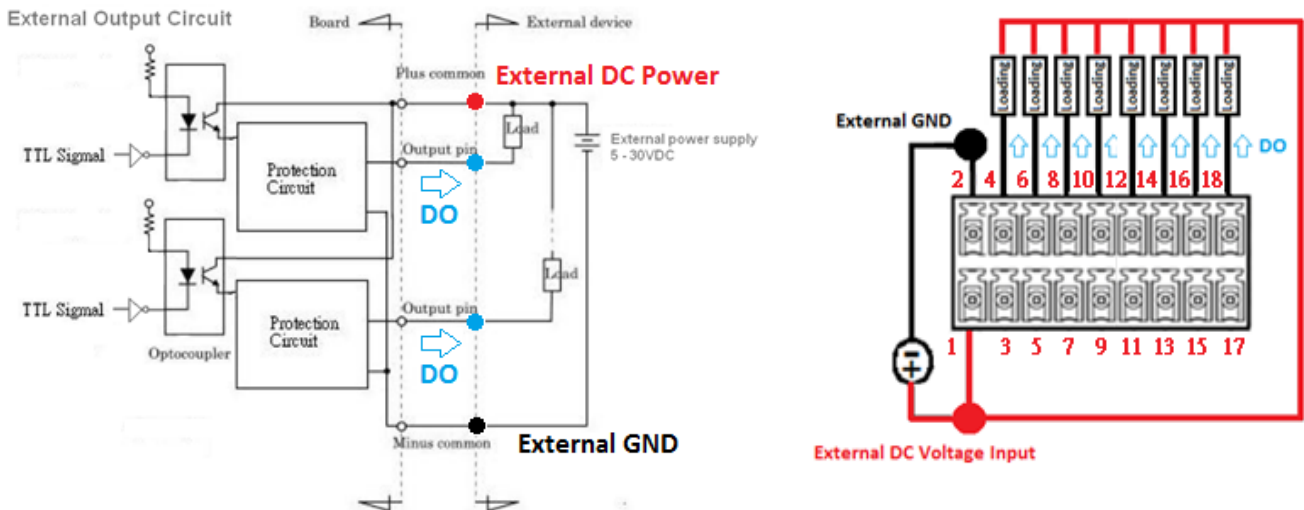

- **CN1, CN2, CN3 : LAN and USB3.0 Port**  
Connector Type: RJ45 port with LEDs and dual USB3.0 ports

Pin	Definition	Pin	Definition	Pin	Definition
1	+5V	10	+5V	20	LAN1_MDI0P
2	USB2_D1-	11	USB2_D2-	21	LAN1_MDI0N
3	USB2_D1+	12	USB2_D2+	22	LAN1_MDI1P
4	GND	13	GND	23	LAN1_MDI2P
5	USB3_RX1-	14	USB3_RX2-	24	LAN1_MDI2N
6	USB3_RX1+	15	USB3_RX2+	25	LAN1_MDI1N
7	GND	16	GND	26	LAN1_MDI3P
8	USB3_TX1-	17	USB3_TX2-	27	LAN1_MDI3N
9	USB3_TX1+	18	USB3_TX2+		

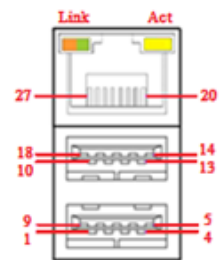

Pin	Definition	Pin	Definition	Pin	Definition
1	+5V	10	+5V	20	LAN2_MDI0P
2	USB2_D3-	11	USB2_D4-	21	LAN2_MDI0N
3	USB2_D3+	12	USB2_D4+	22	LAN2_MDI1P
4	GND	13	GND	23	LAN2_MDI2P
5	USB3_RX3-	14	USB3_RX4-	24	LAN2_MDI2N
6	USB3_RX3+	15	USB3_RX4+	25	LAN2_MDI1N
7	GND	16	GND	26	LAN2_MDI3P
8	USB3_TX3-	17	USB3_TX4-	27	LAN2_MDI3N
9	USB3_TX3+	18	USB3_TX4+		

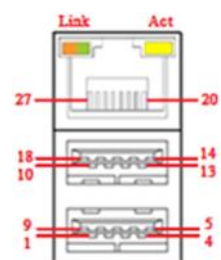

Pin	Definition	Pin	Definition	Pin	Definition
1	+5V	10	+5V	20	LAN3_MDI0P
2	USB2_D5-	11	USB2_D6-	21	LAN3_MDI0N
3	USB2_D5+	12	USB2_D6+	22	LAN3_MDI1P
4	GND	13	GND	23	LAN3_MDI2P
5	USB3_RX5-	14	USB3_RX6-	24	LAN3_MDI2N
6	USB3_RX5+	15	USB3_RX6+	25	LAN3_MDI1N
7	GND	16	GND	26	LAN3_MDI3P
8	USB3_TX5-	17	USB3_TX6-	27	LAN3_MDI3N
9	USB3_TX5+	18	USB3_TX6+		

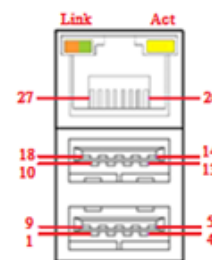

Link LED Status	Definition
Steady Green	1Gbps Network Link
Steady Orange	100Mbps Network Link
Off	10Mbps Network Link

Active LED Status	Definition
Blinking Yellow	Data Activity
Off	No Activity

■ **MINIPCIE1 : Mini PCI-Express Socket (Support mPCIe, USB2.0 and SIM Card to Link Feature)**

Pin	Definition	Pin	Definition
1	WAKE#	2	+3.3Vaux
3	NA	4	GND
5	NA	6	+1.5V
7	CLKREQ7#	8	UIM1_PWR
9	GND	10	USIM1_DATA
11	PCIE_CLK7-	12	USIM1_CLK
13	PCIE_CLK7+	14	USIM1_RST
15	GND	16	USIM1_VPP
17	RESERVED	18	GND
19	RESERVED	20	W_DISABLE#
21	GND	22	RESET#
23	PCIE_RXN8	24	+3.3Vaux
25	PCIE_RXP8	26	GND
27	GND	28	+1.5V
29	GND	30	SMB_CLK
31	PCIE_TXN8	32	SMB_DATA
33	PCIE_TXP8	34	GND

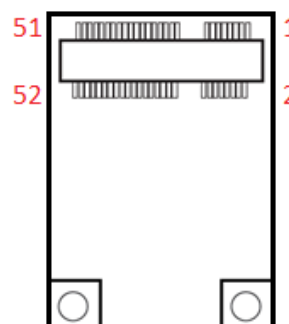

35	GND	36	USB_D11-
37	GND	38	USB_D11+
39	+3.3Vaux	40	GND
41	+3.3Vaux	42	NA
43	GND	44	NA
45	NA	46	NA
47	NA	48	+1.5V
49	NA	50	GND
51	NA	52	+3.3Vaux

**WARNING:**

**SOME OFF-THE-SHELF MINI-PCIE MODULES ARE NOT COMPATIBLE WITH +3.3VAUX POWER AND ARE ONLY COMPATIBLE WITH +3.3V POWER DESIGN. IF A SIMILAR SITUATION ARISES, PLEASE CONTACT ARESTECH FOR SOLUTIONS.**

■ **MINIPCIE2 : Mini PCI-Express Socket (Support mPCIe, USB2.0 and SIM Card to Link Feature)**

Pin	Definition	Pin	Definition
1	WAKE#	2	+3.3Vaux
3	NA	4	GND
5	NA	6	+1.5V
7	CLKREQ8#	8	UIM2_PWR
9	GND	10	USIM2_DATA
11	PCIE_CLK8-	12	USIM2_CLK
13	PCIE_CLK8+	14	USIM2_RST
15	GND	16	USIM2_VPP
17	RESERVED	18	GND
19	RESERVED	20	W_DISABLE#
21	GND	22	RESET#
23	PCIE_RXN19	24	+3.3Vaux
25	PCIE_RXP19	26	GND
27	GND	28	+1.5V
29	GND	30	SMB_CLK
31	PCIE_TXN19	32	SMB_DATA
33	PCIE_TXP19	34	GND
35	GND	36	USB_D12-
37	GND	38	USB_D12+
39	+3.3Vaux	40	GND

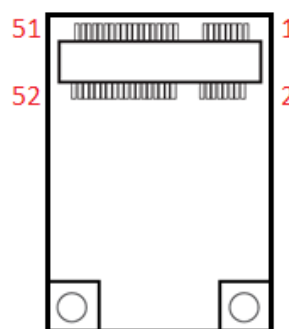

41	+3.3Vaux	42	NA
43	GND	44	NA
45	NA	46	NA
47	NA	48	+1.5V
49	NA	50	GND
51	NA	52	+3.3Vaux



**WARNING:**

SOME OFF-THE-SHELF MINI-PCIE MODULES ARE NOT COMPATIBLE WITH +3.3VAUX POWER AND ARE ONLY COMPATIBLE WITH +3.3V POWER DESIGN. IF A SIMILAR SITUATION ARISES, PLEASE CONTACT ARESTECH FOR SOLUTIONS.

■ **CN4 : Dual Mode Mini PCI-Express (Support mPCIe, mSATA, USB2.0 and SIM Card to Link Feature)**

Pin	Definition	Pin	Definition
1	WAKE#	2	+3.3Vaux
3	NA	4	GND
5	NA	6	+1.5V
7	CLKREQ9#	8	USIM3_PWR
9	GND	10	USIM3_DATA
11	PCIE_CLK9-	12	USIM3_CLK
13	PCIE_CLK9+	14	USIM3_RST
15	GND	16	USIM3_VPP
17	RESERVED	18	GND
19	RESERVED	20	W_DISABLE#
21	GND	22	RESET#
23	PCIE_RXN17 (SATA_RXP4)	24	+3.3Vaux
25	PCIE_RXP17 (SATA_RXN4)	26	GND
27	GND	28	+1.5V
29	GND	30	SMB_CLK
31	PCIE_TXN17 (SATA_TXN)	32	SMB_DATA
33	PCIE_TXP17 (SATA_TXP4)	34	GND
35	GND	36	USB_D4-
37	GND	38	USB_D4+
39	+3.3Vaux	40	GND
41	+3.3Vaux	42	NA
43	GND	44	NA

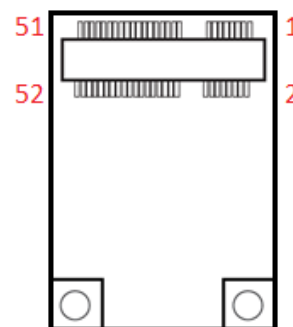

45	NA	46	NA
47	NA	48	+1.5V
49	NA	50	GND
51	NA	52	+3.3Vaux

■ **CN5 : Dual Mode Mini PCI-Express (Support mPCIe, mSATA, USB2.0 and SIM Card to Link Feature)**

Pin	Definition	Pin	Definition
1	WAKE#	2	+3.3Vaux
3	NA	4	GND
5	NA	6	+1.5V
7	CLKREQ10#	8	USIM4_PWR
9	GND	10	USIM4_DATA
11	PCIE_CLK10-	12	USIM4_CLK
13	PCIE_CLK10+	14	USIM4_RST
15	GND	16	USIM4_VPP
17	RESERVED	18	GND
19	RESERVED	20	W_DISABLE#
21	GND	22	RESET#
23	PCIE_RXN18 (SATA_RXP5)	24	+3.3Vaux
25	PCIE_RXP18 (SATA_RXN5)	26	GND
27	GND	28	+1.5V
29	GND	30	SMB_CLK
31	PCIE_TXN18 (SATA_TXN5)	32	SMB_DATA
33	PCIE_TXP18 (SATA_TXP5)	34	GND
35	GND	36	USB_D14-
37	GND	38	USB_D14+
39	+3.3Vaux	40	GND
41	+3.3Vaux	42	NA
43	GND	44	NA
45	NA	46	NA
47	NA	48	+1.5V
49	NA	50	GND
51	NA	52	+3.3Vaux

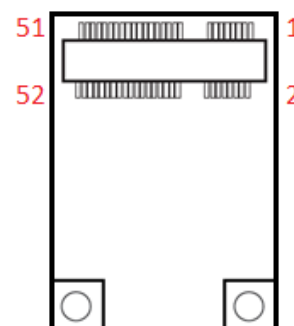

## Chapter 3. System Setup



### WARNING:

TO PREVENT ELECTRIC SHOCK OR SYSTEM DAMAGE, PLEASE MUST TURN OFF THE POWER AND DISCONNECT THE DEVICE FROM THE POWER SOURCE BEFORE REMOVING THE BOTTOM CHASSIS COVER.

### 3.1 Removing CPU Heat Sink Cover

1. Turn over the system to have the CPU heat sink side face up and loosen the 8 screws on the left and right sides.

Left Side



Right Side



2. Remove the CPU heat sink cover.





## 3.2 Installing CPU

1. You can locate the CPU socket after the CPU heat sink cover is removed.

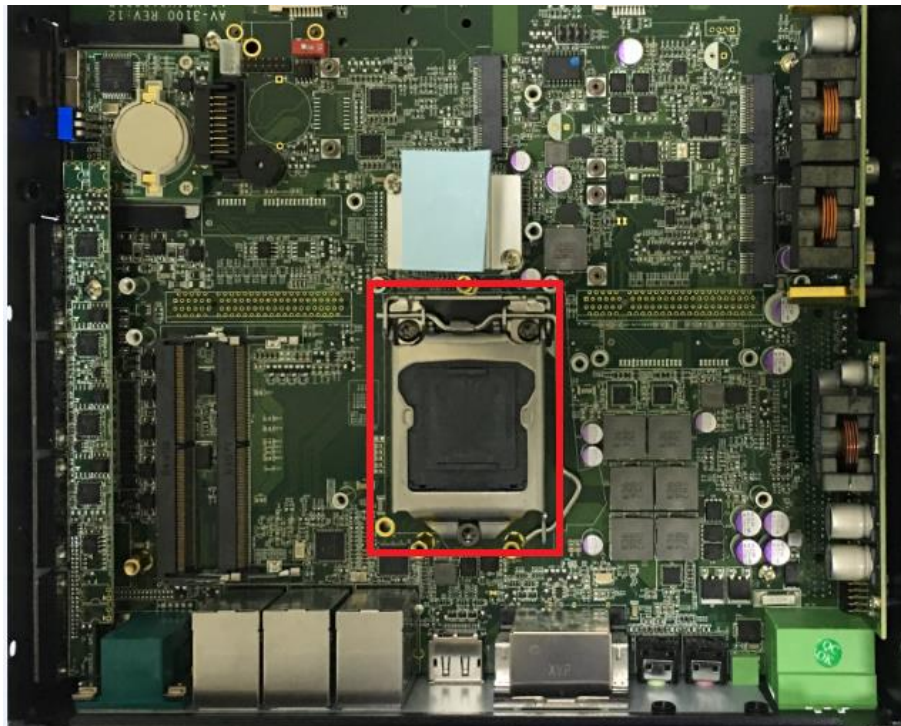

2. Press down the CPU socket lever to open the socket cover.



3. Remove the CPU socket protective cover.

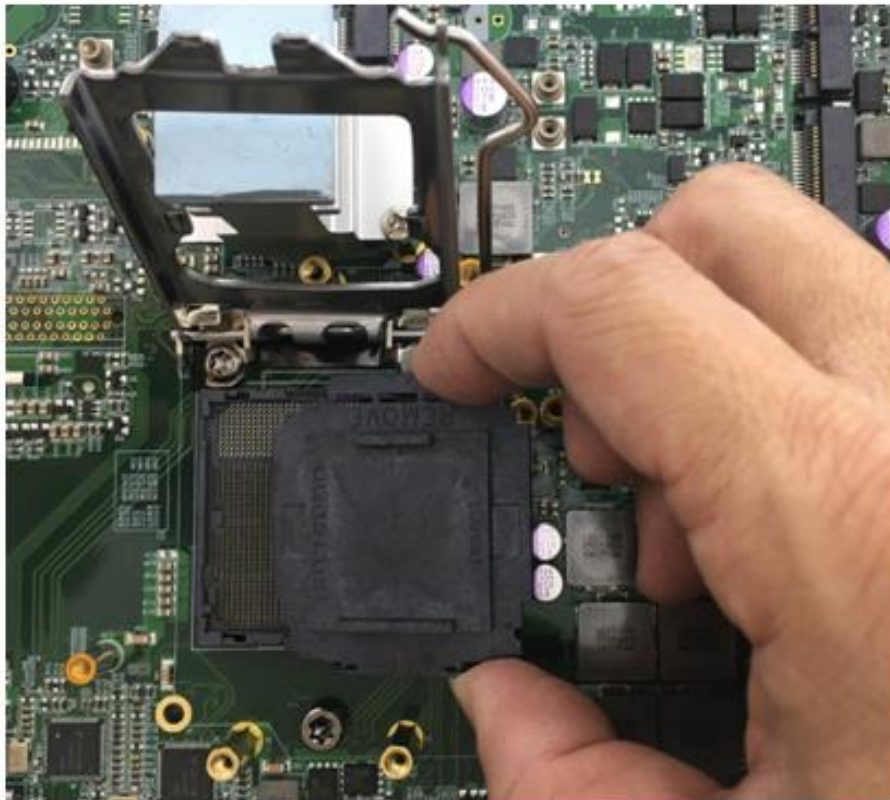

4. Install the CPU in the direction indicated by the arrow.

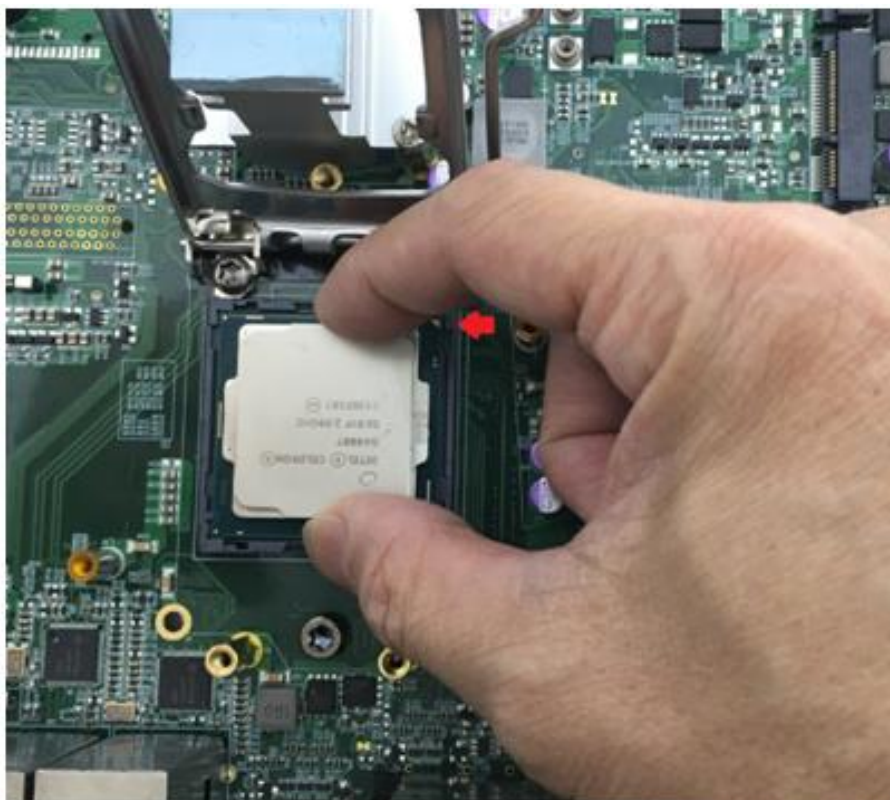



5. Press down the lever to hold the CPU socket cover.



6. Paste the thermal pad on the CPU.

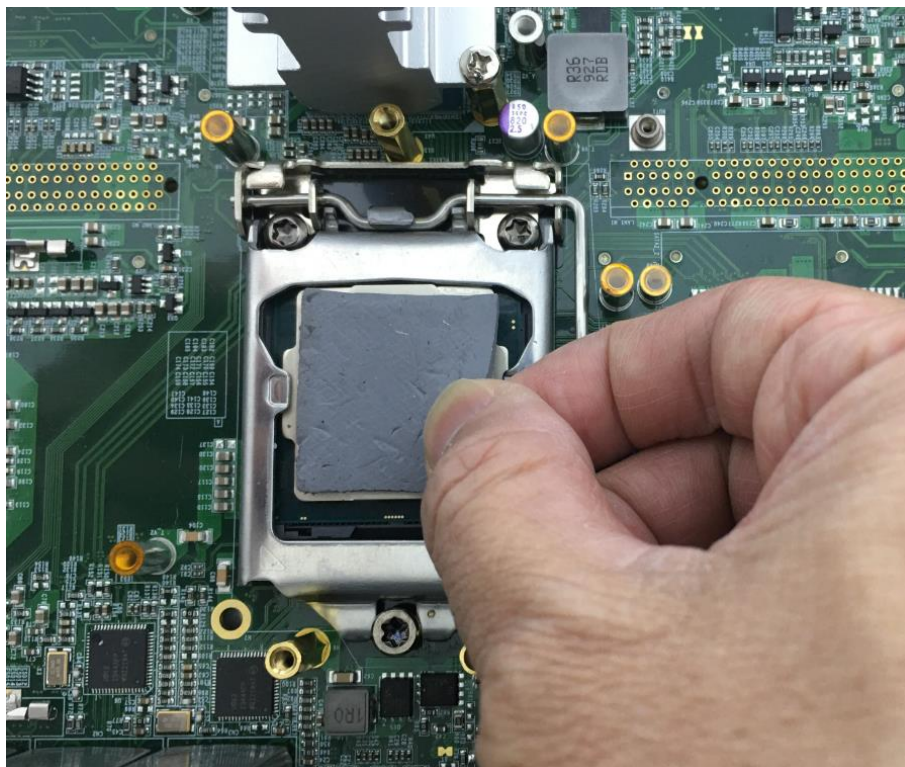

7. Place the CPU heat block onto the thermal pad.

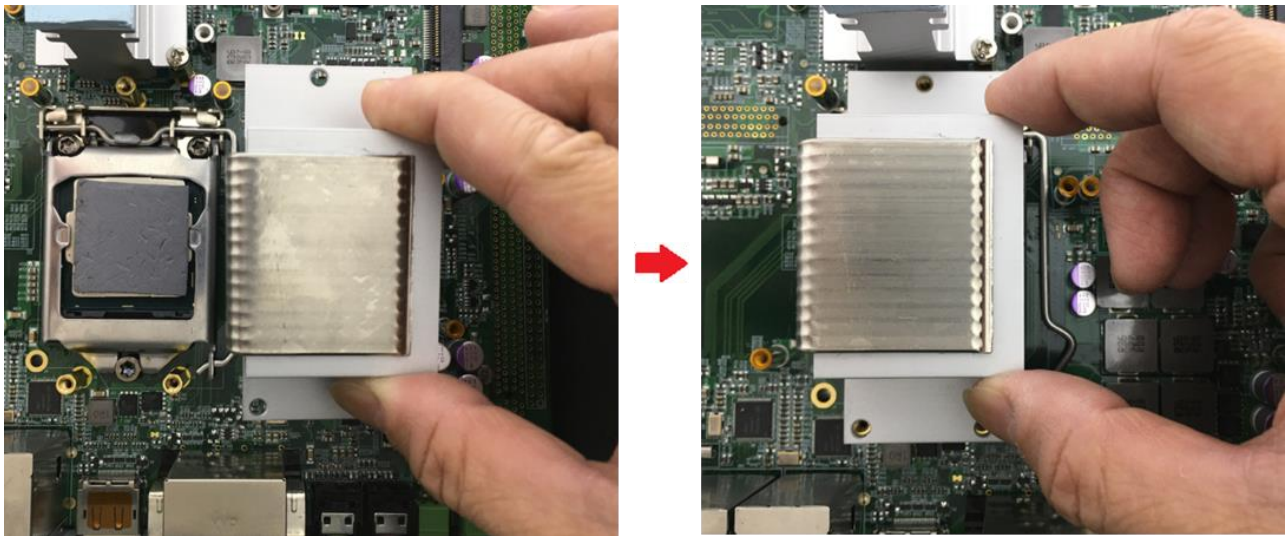

8. Lock the CPU heat sink with three screws.

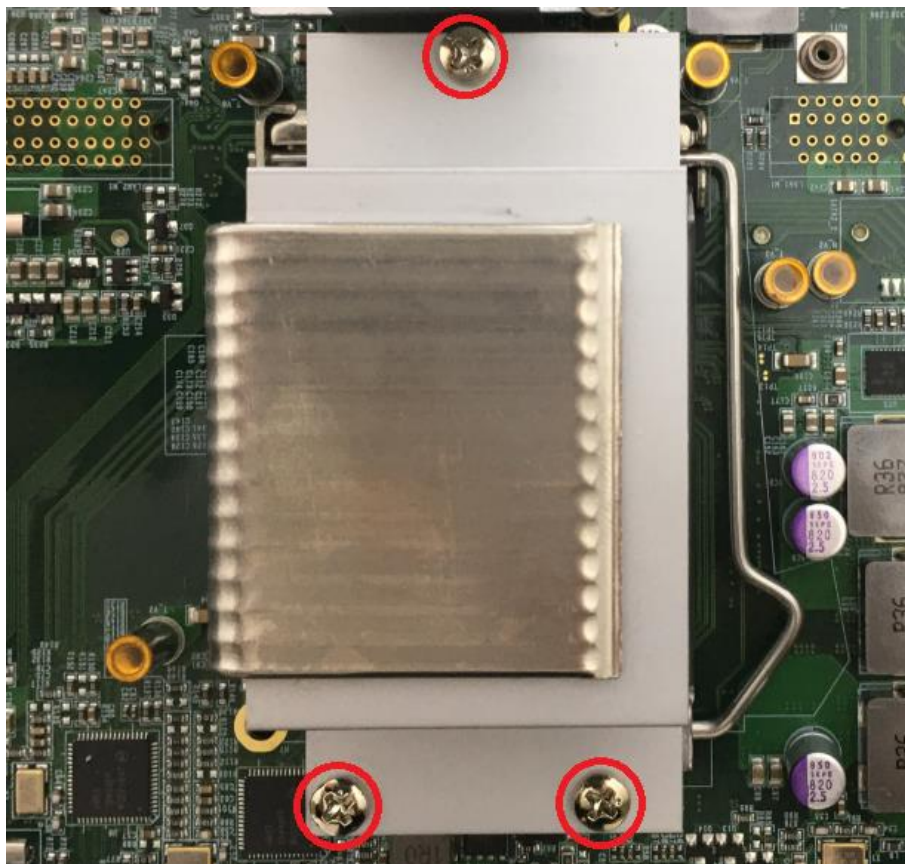



9. Paste the thermal pad onto the installed CPU heat block.

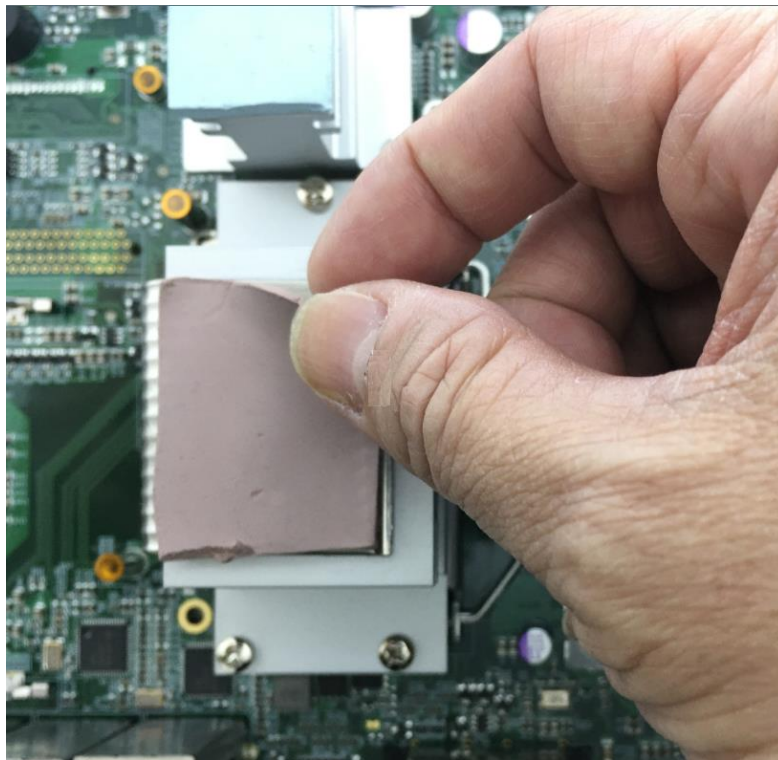

10. The installation is complete.

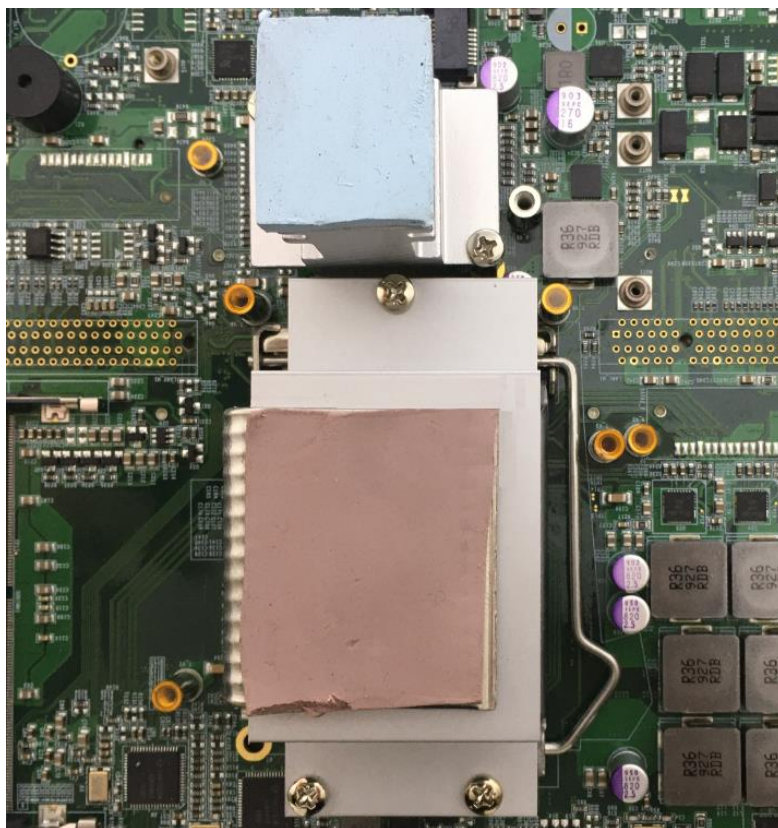

### 3.3 Installing A SODIMM

1. Two SODIMM sockets are available for MEGA-3110 series on the motherboard top side.  
Locate SODIMM socket.

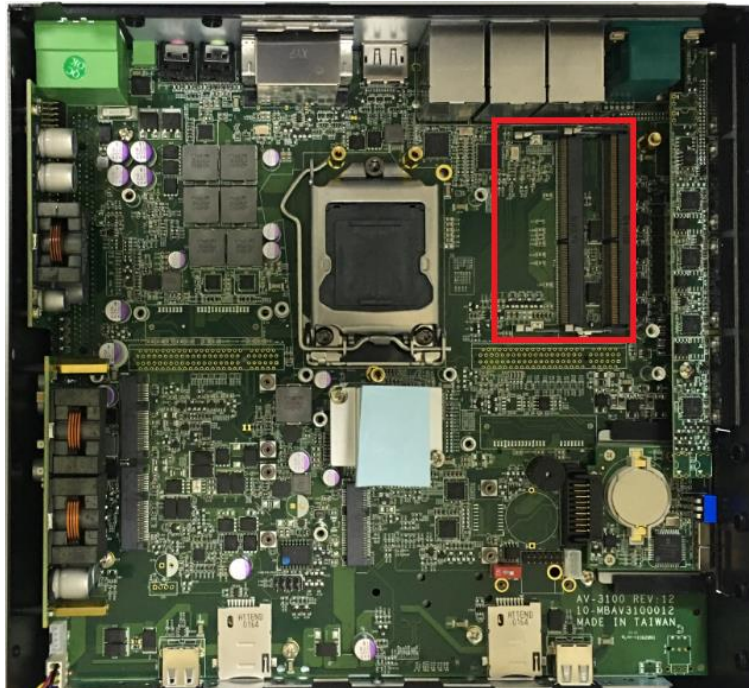

2. Insert the DDR4-SODIMM module at 45-degree angle.

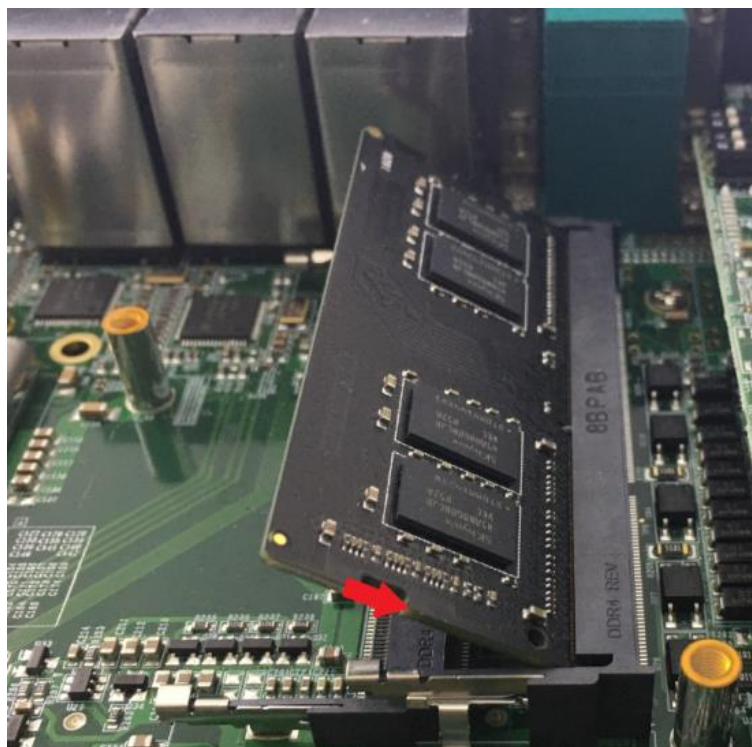

3. Press the module down until it's fixed firmly by the two locking latches.

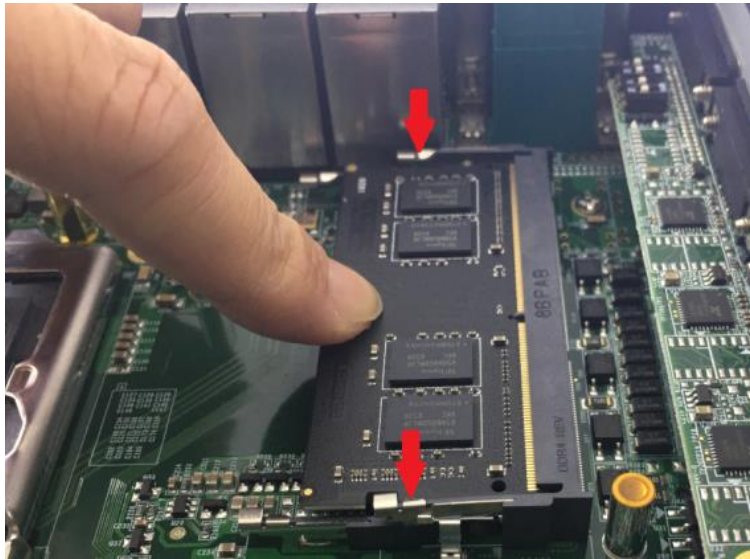



## 3.4 Installing A Mini-PCIe or mSATA Module

- Four Mini-PCIe sockets are available for MEGA-3110 series. The top CN4 and CN5 can also support mSATA.

Top Side (MINIPCE1, CN4, CN5)

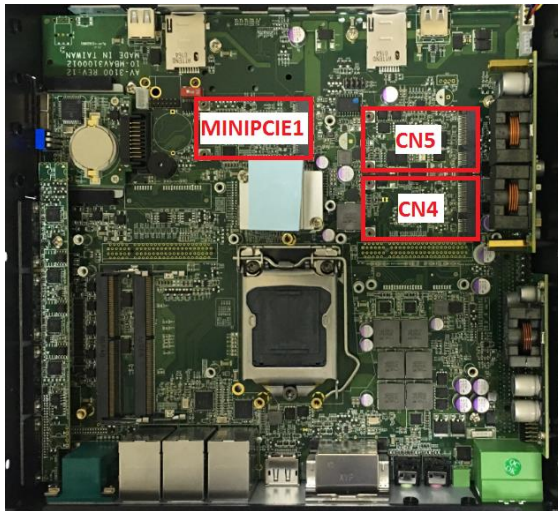

Bottom Side (MINIPCE2)



- Insert the Mini-PCIe or mSATA module at 45-degree angle.

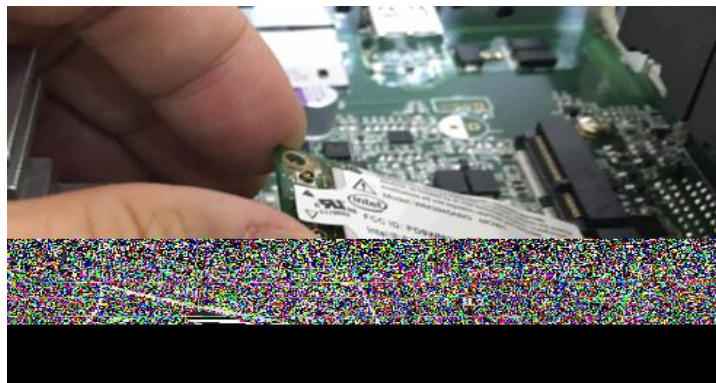

- Press the Mini-PCIe or mSATA module down and lock it with two screws.





## 3.5 Installing An Antenna

1. Four antenna holes are available for MEGA-3110 series on the front and top panel.

### Front Panel

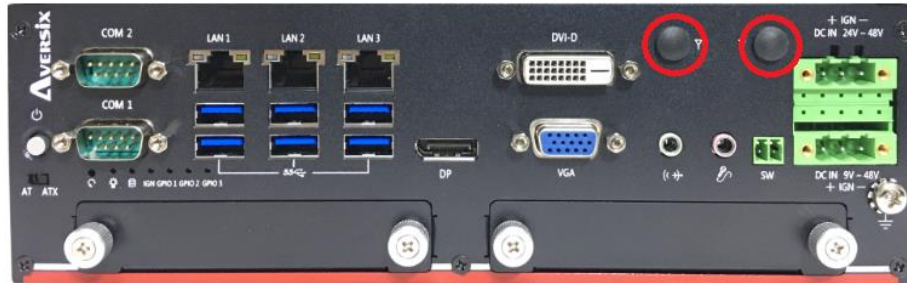

### Top Panel



2. Remove the antenna hole covers on the front or top panel.



3. Have the antenna jack penetrate through the hole.



4. Put on the washer and fasten the nut with antenna jack



5. Assemble the antenna and antenna jack together.

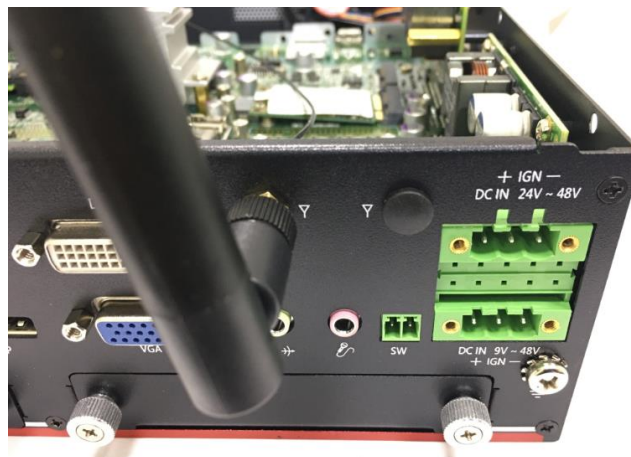

6. Attach the RF connector at the cable-end onto the Mini-PCle Wi-Fi module.



### 3.6 Installing A Removable SATA HDD Bay

1. The MEGA-3110 series has two removable SATA HDD bays on the front panel.
2. Unscrew the two thumb screws circled below to remove the removable 2.5" SATA HDD bay.



3. Lock the 2.5" SATA HDD with HDD bay using four screws.



4. Slide the HDD bay back and fasten the thumb screws.

### 3.7 Installing An Internal SATA HDD Bay

1. Turn the system over so that the CPU heat sink is facing down and you'll see the two internal HDD bracket covers.
2. Unscrew the 3 screws to remove the internal HDD bracket cover.

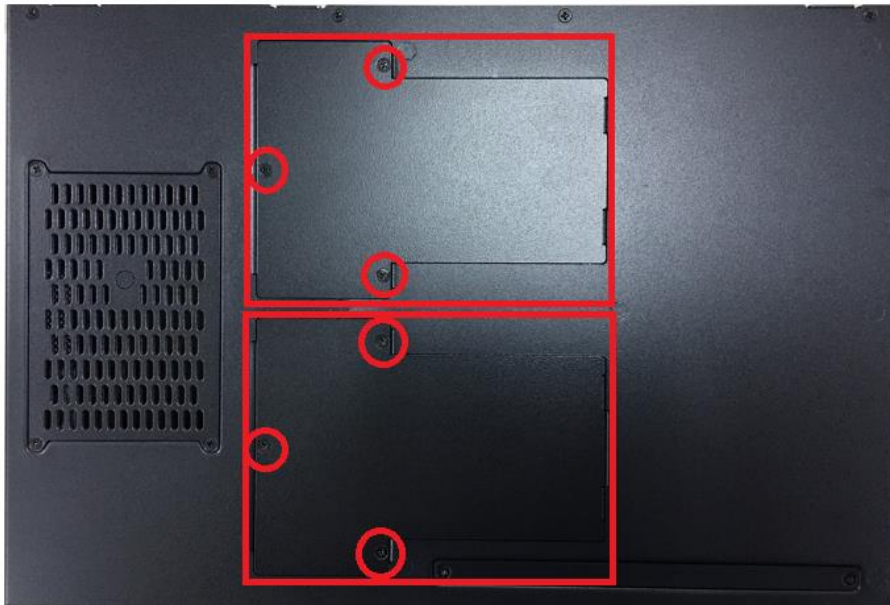

3. You can locate the internal HDD bay after the HDD bracket cover is removed.

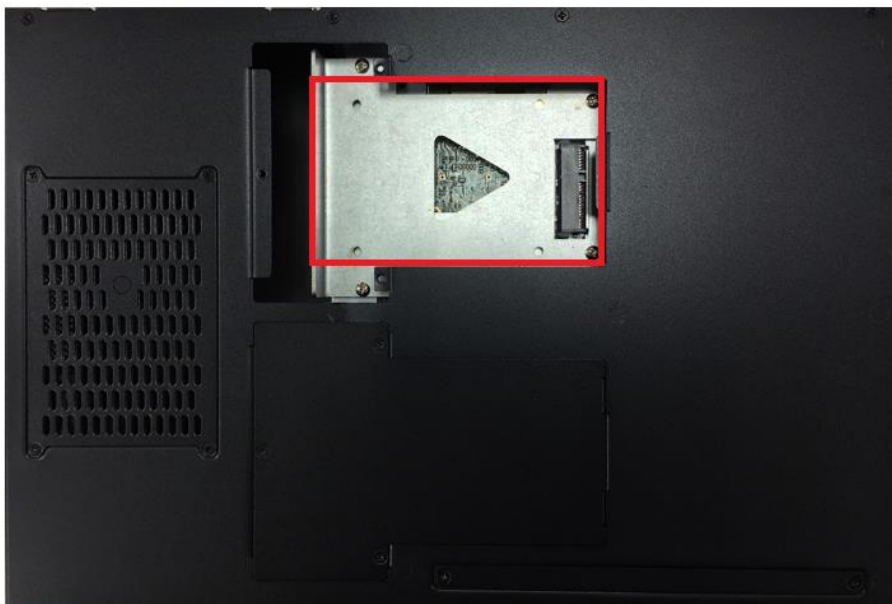



4. Unscrew the 4 screws to remove the internal HDD bay.

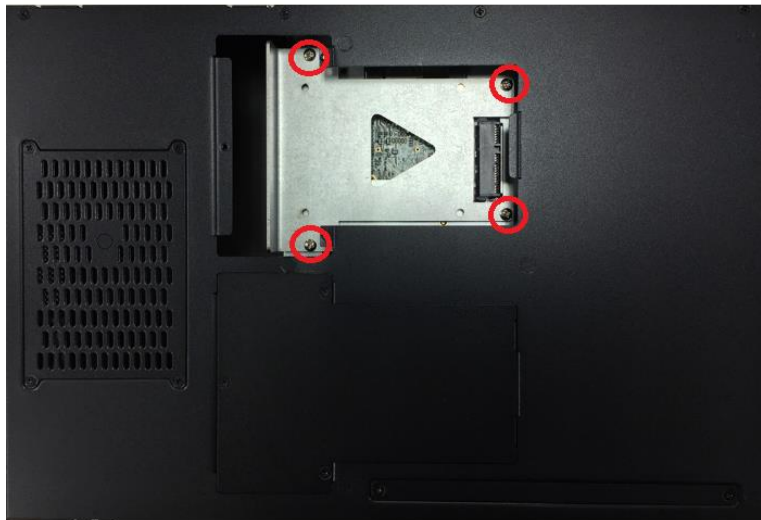

5. Lock the 2.5" SATA HDD with HDD bay by using 4 screws.

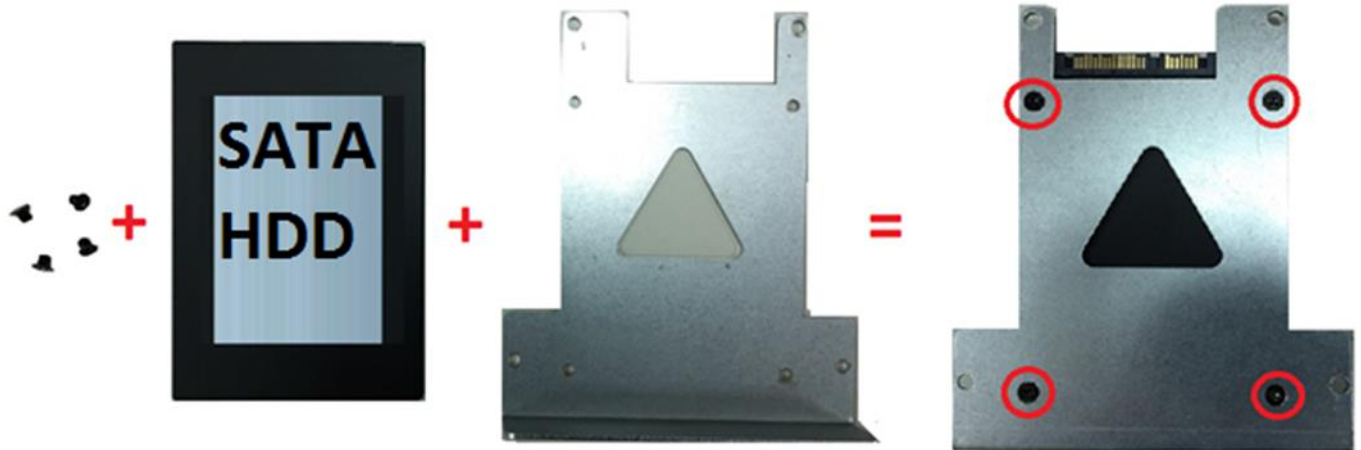

6. Install the HDD bracket by following the direction below.

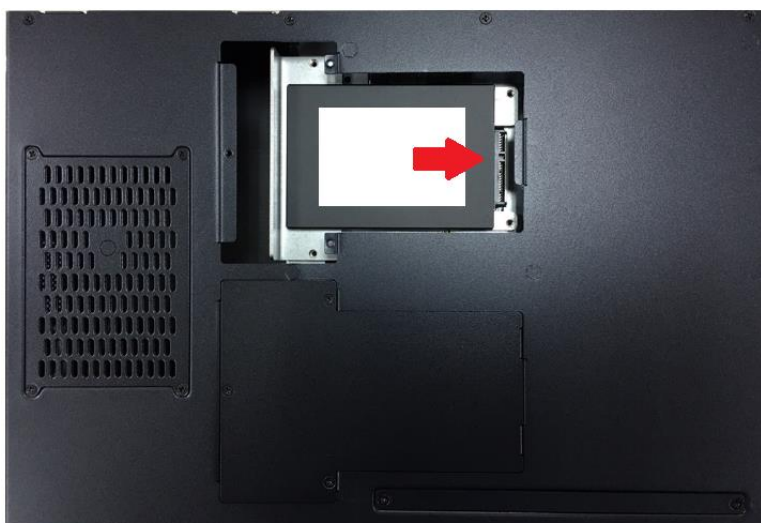

7. Fasten the four screws to lock the internal HDD bay.

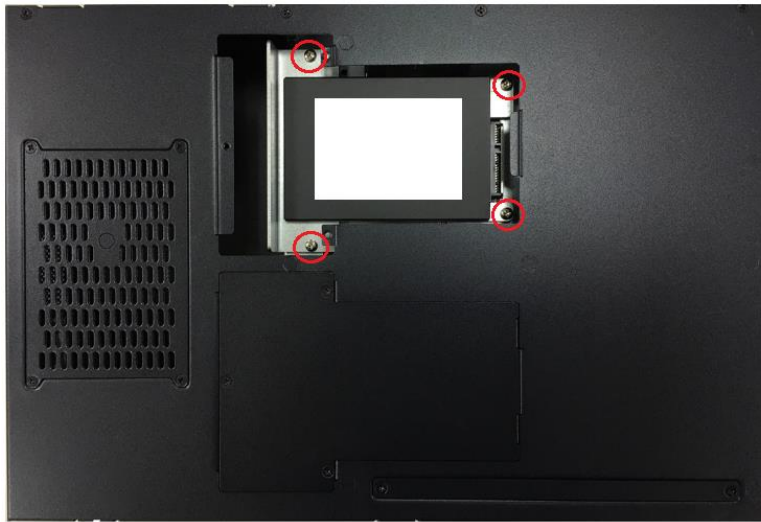

### 3.8 Installing A CFast1/2 or SIM1/2 Card

1. Two CFast sockets are on the top side of the system. Unscrew the two screws to remove the CFast1 / SIM or CFast2 cover plate.



2. Insert the Cfast / SIM card into the socket.



© **NOTE:**

**WHEN YOU WANT TO UNINSTALL THE SIM CARD OR CFAST CARD, PLEASE SIMPLY PRESS THE INSTALLED SIM CARD OR CFAST CARD TO EJECT THE CARD OUT.**

### 3.9 Installing An Internal SIM3/4 Card

1. Remove the CPU heat sink cover and then turn the system so that the rear panel is facing forward. Locate the internal SIM3/SIM4 socket.

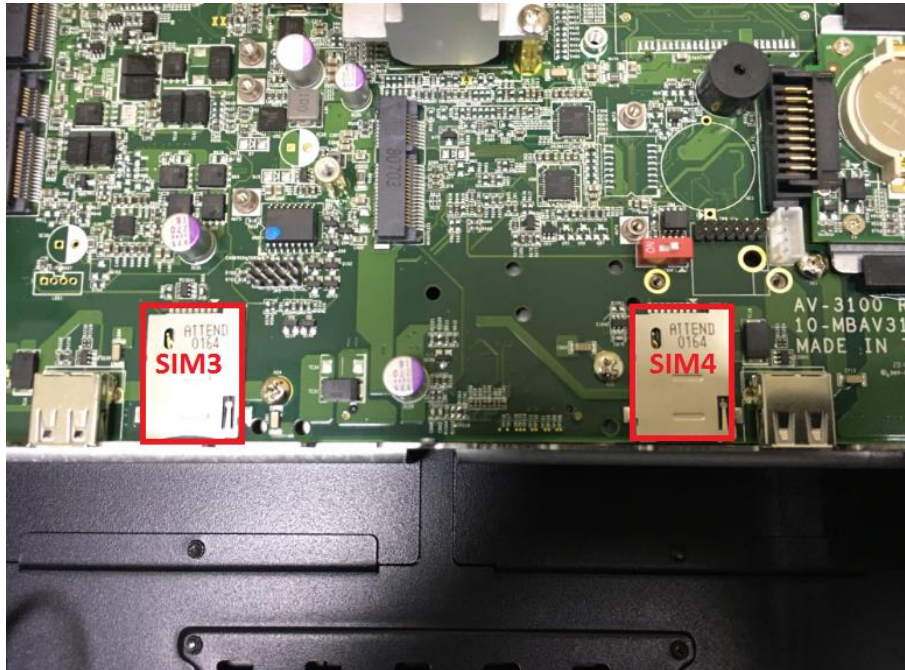

2. Insert the SIM card into the socket.

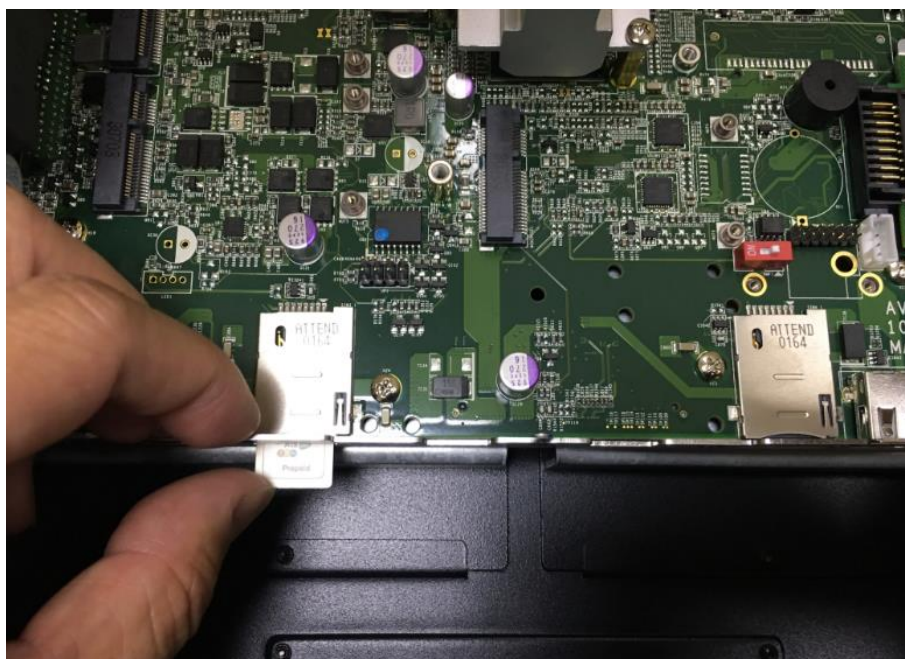

© NOTE:

1. PLEASE NOTE THAT THE INSTALLATION OF SIM1\_1, SIM2\_1, SIM3\_1 AND SIM4\_1 HAS TO MATCH THE INSTALLATION OF MINI-PCIE SOCKETS.



SIM Card Socket Number	Matching Mini-PCIe Socket
SIM1_1	MINIPCI1
SIM2_1	MINIPCI2
SIM3_1	CN4
SIM4_1	CN5

2. WHEN YOU WANT TO UNINSTALL THE SIM CARD OR CFAST CARD, PLEASE SIMPLY PRESS THE INSTALLED SIM CARD OR CFAST CARD TO EJECT THE CARD OUT.

### 3.10 Changing A CMOS Battery

1. The CMOS battery can be replaced from the top panel of the system. Unscrew the two screws to remove the CFast1/ SIM cover plate.

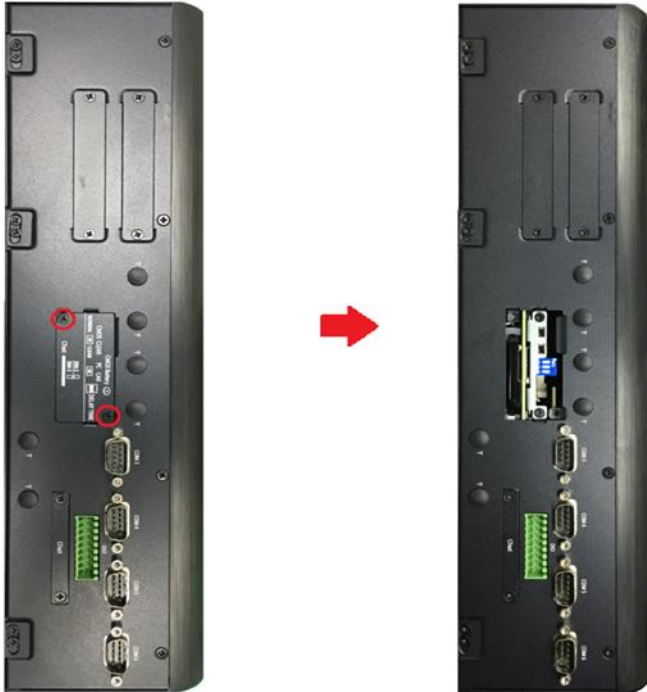

2. Unscrew the two screws to pull out the CMOS battery.



### 3.11 Assembly the CPU Heat Sink Cover

1. Please make sure that the thermal pad is attached to the CPU heat sink and PCH heat sink.

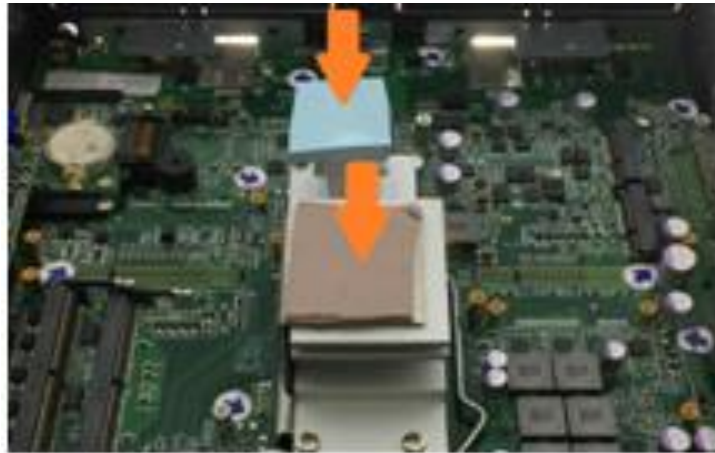

2. Close the CPU heat sink cover.
3. Fasten the 8 screws on the system left side and right side.

Left Side



Right Side

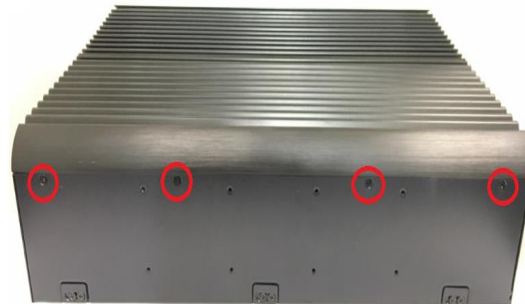

### 3.12 Installing A PCIe Expansion Card

1. Unscrew the two thumb screws on the front side of expansion module.

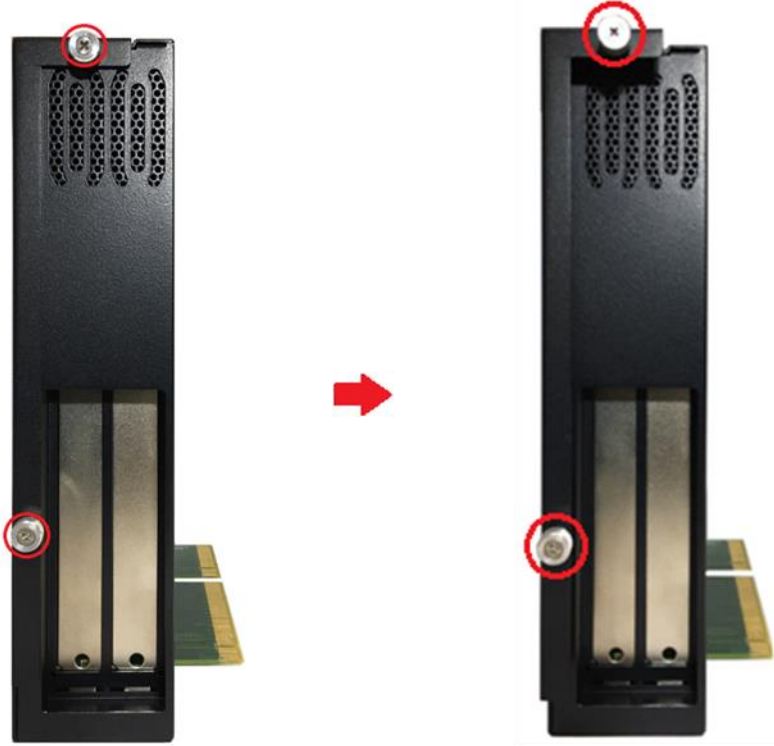

2. Pull the thumb screw in the following direction to open the expansion box cover.

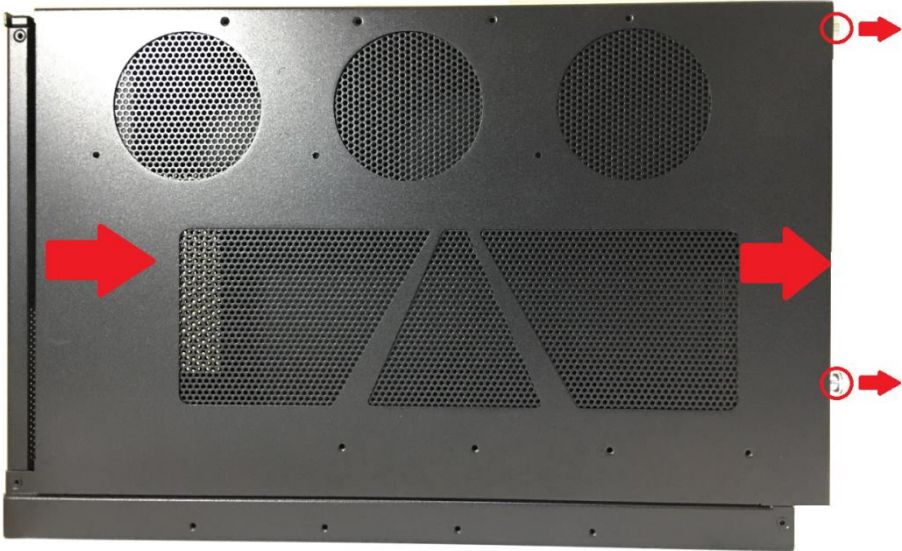

3. Unscrew the screw securing the PCIe card bracket to remove the bracket.

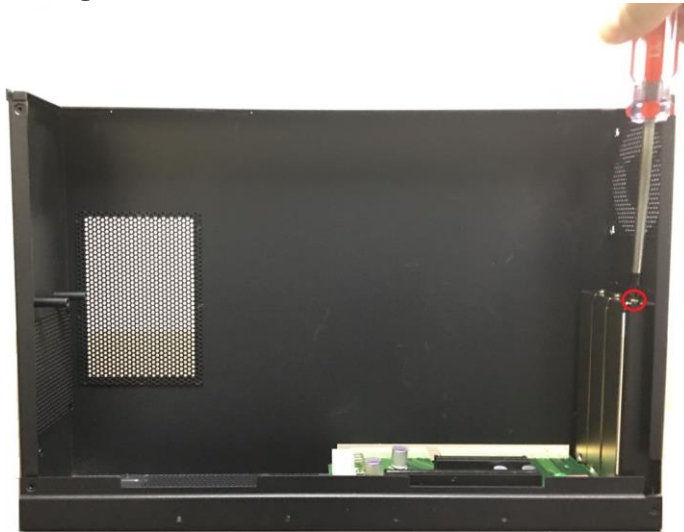

4. Insert the PCIe card into the expansion slot.

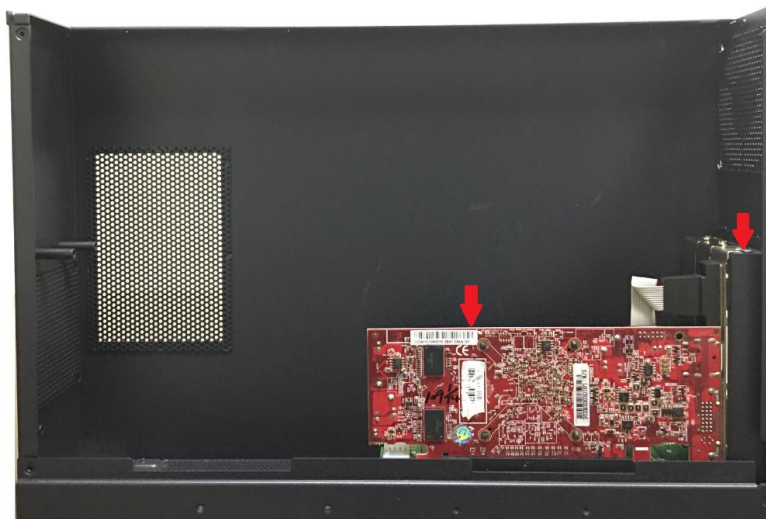

5. Install the screws back to secure the PCIe card.

6. Install the fan back to its original position and lock the four screws in the direction indicated below.

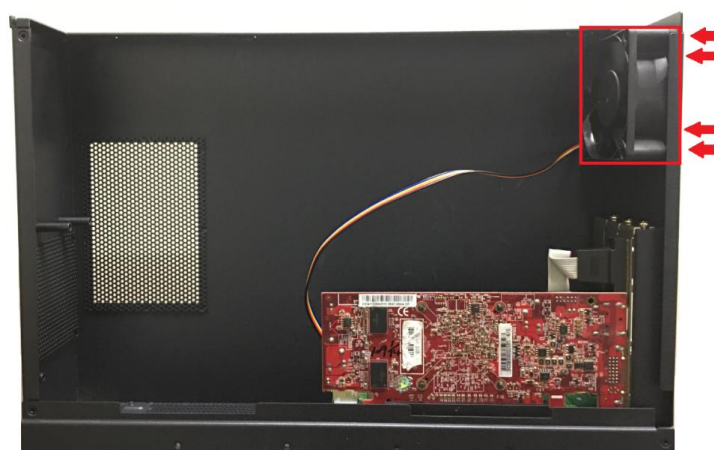



7. Close the chassis cover and tighten the thumb screws.

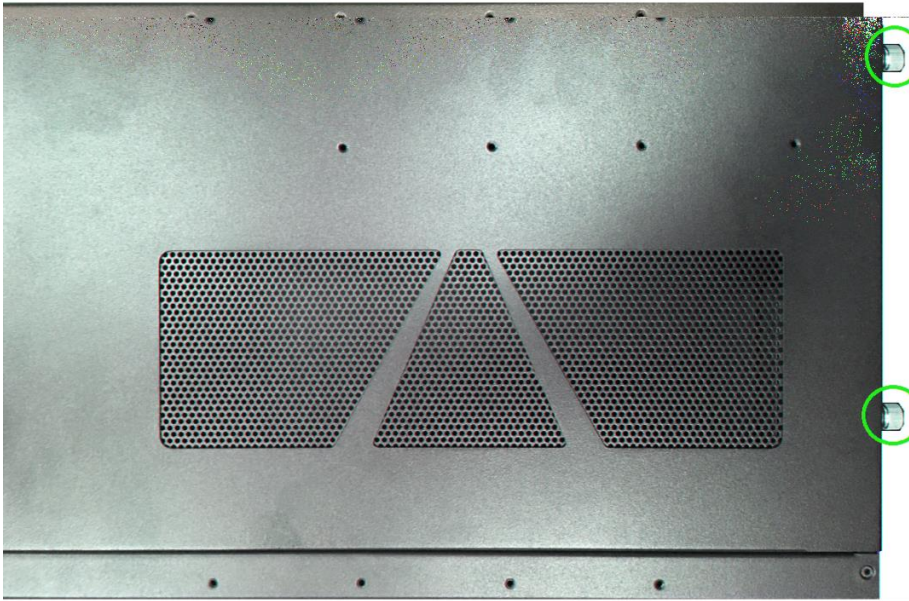

### 3.13 Connecting The Expansion Module with The PC Module

1. Connect the expansion module with the PC module by inserting the gold fingers on the expansion module into the slot.



2. Fasten all screws using the connection brackets on the top and bottom of the system.

**Top Side**

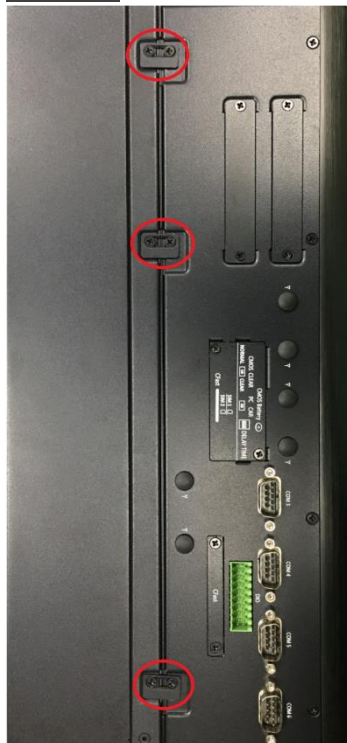

**Bottom Side**



### 3.14 Installing A Stand / Wall Mount

1. Wall mount kit is included in the standard package.



2. Lock the wall mount kit with 8 screws on the bottom or left side of the system.

Bottom Side

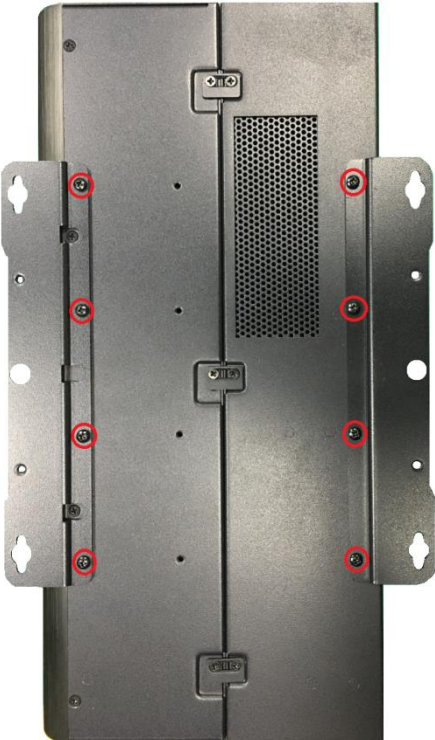

Left Side

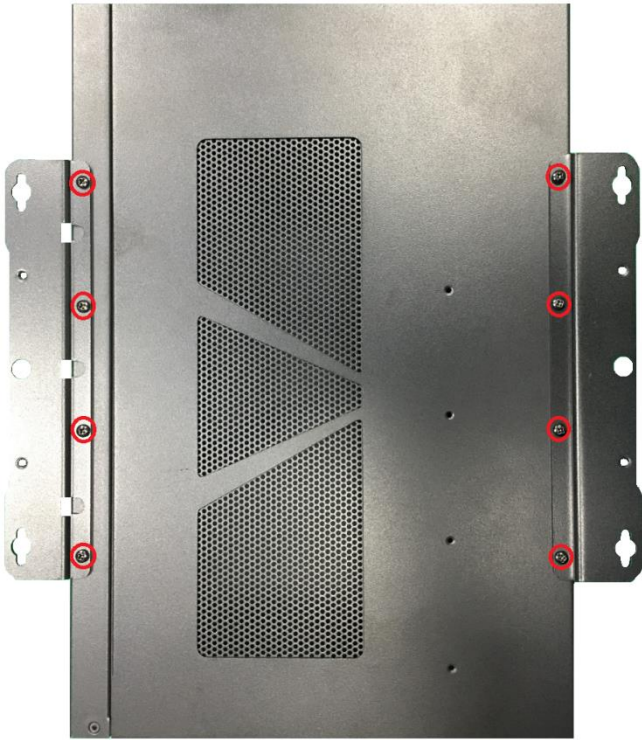



## Chapter 4. BIOS Setup

### 4.1 BIOS Introduction

The system BIOS software is stored on EEPROM. The BIOS provides an interface to modify the configuration. When the battery is removed, all the parameters will be reset.

#### ■ BIOS Setup

Power on the embedded system and by pressing <Del> or <F2> immediately allows you to enter the setup screens. If the message disappears before you respond, and you still wish to enter the Setup, please restart the system by turning it OFF and ON or pressing the RESET button. You may also restart the system by simultaneously pressing <Ctrl>, <Alt>, and <Delete> keys.

Control Keys	
<←> <→>	Select Screen
<↑> <↓>	Select Item
<Enter>	Select
<Page Up/+>	Increases the numeric value or makes changes
<Page Down/->	Decreases the numeric value or makes changes
<F1>	General Help
<F2>	Previous Value
<F3>	Load Optimized Defaults
<F10>	Save Configuration and Exit
<Tab>	Select Setup Fields
<Esc>	Exit BIOS Setup

#### ■ Main Setup

The main menu lists the setup functions you can make changes to. You can use the arrow keys ( ↑ ↓ ) to select the item. The on-line description of the highlighted setup function is displayed at the bottom of the screen.

#### ■ General Help <F1>

The BIOS setup program provides a General Help screen. You can call up this screen from any menu by simply pressing <F1>. The Help screen lists the appropriate keys to use and the possible selections for the highlighted item. Press <Esc> to exit the Help screen.

## 4.2 Main Setup

Press <Del> to enter BIOS CMOS Setup Utility. The Main setup screen is showed as follows when the setup utility is entered. System Date/Time is set up in the Main Menu.



- **System Date**  
Use the system date option to set the system date.
- **System Time**  
Use the system time option to set the system time.

## 4.3 Advanced Setup

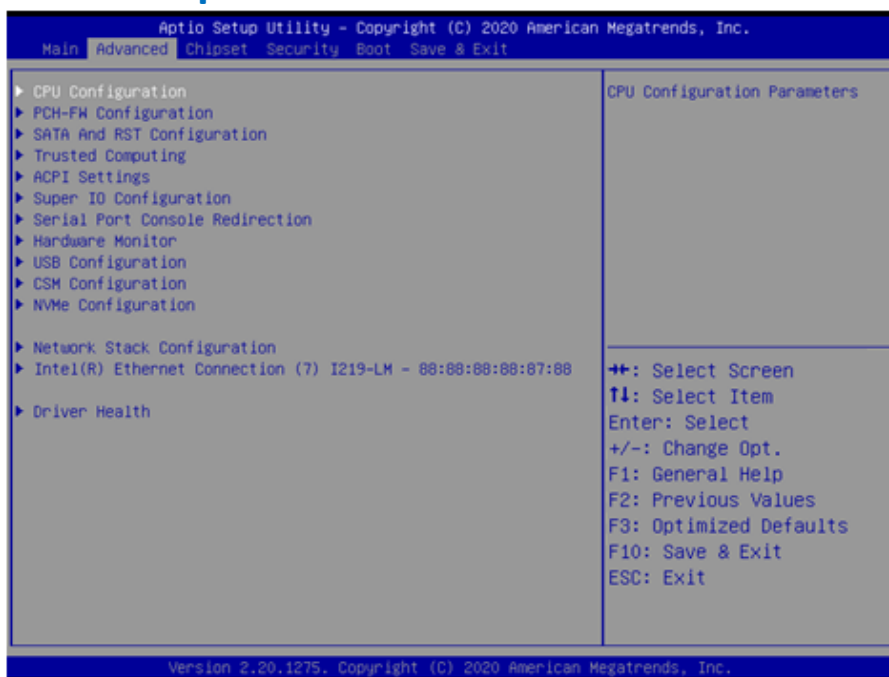

### 4.3.1 CPU Configuration



- **Intel (VMX) Virtualization Technology**

This item allows you to enable or disable Intel (VMX) Virtualization Technology. VT allows a single platform to run multiple operating systems in independent partitions.

- **Active Processor Cores**

This item allows you to choose the number of active processor cores.

## 4.3.2 PCH-FW Configuration

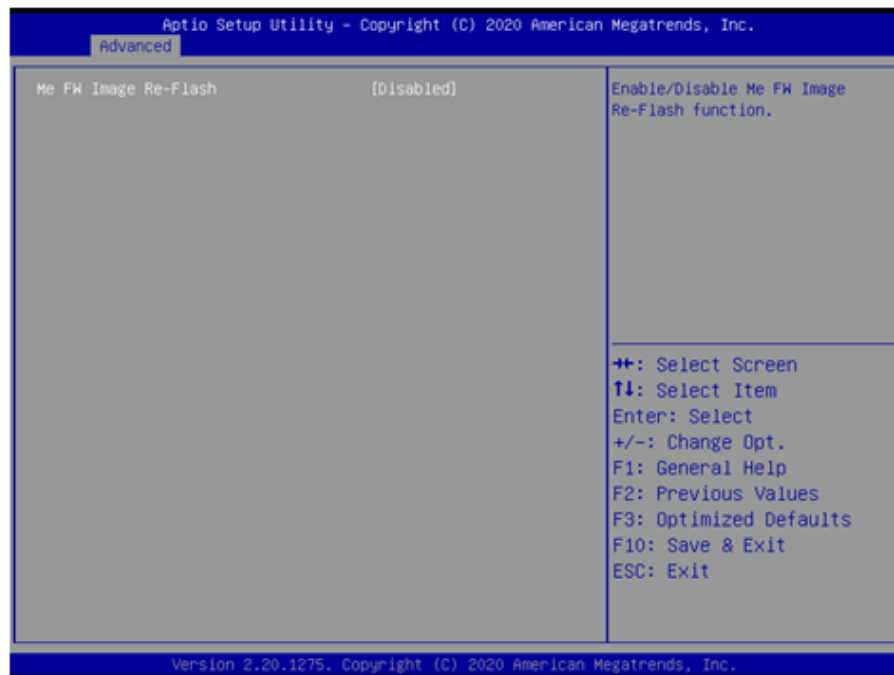

### ■ Me FW Image Re-Flash

This item allows you to enable or disable Me FW image re-flash function.

### 4.3.3 SATA & RST Configuration



- **SATA Controller(s)**  
This item allows you to enable or disable SATA device.
- **SATA Mode Selection**  
This item allows you to select which mode SATA controller will operate.  
Select <AHCI> or <Intel RST Premium with Intel Optane System Acceleration> mode.
- **SATA Port 1**  
This item allows you to enable or disable SATA Port 1.
- **SATA Port 2**  
This item allows you to enable or disable SATA Port 2.
- **SATA Port 3**  
This item allows you to enable or disable SATA Port 3.
- **SATA Port 4**  
This item allows you to enable or disable SATA Port 4.
- **SATA Port 5**  
This item allows you to enable or disable SATA Port 5 (CN4-mSATA/CFast1).
- **SATA Port 6**  
This item allows you to enable or disable SATA Port 6 (CN5-mSATA/CFast2).

## 4.3.4 Trusted Computing



### ■ Security Device Support

This item allows you to enable or disable BIOS support for security device. O.S. will not show Security Device. TCG EFI protocol and INT1A interface will not be available.

### ■ SHA-1 PCR Bank

This item allows you to enable or disable SHA-1 PCR Bank.

### ■ SHA256 PCR Bank

This item allows you to enable or disable SHA256 PCR Bank.

### ■ Pending Operation

Schedule an operation for the security device.

[None]: No operation.

[TPM Clear]: Clear TPM status.

### ■ Platform Hierarchy

This item allows you to enable or disable platform hierarchy.

### ■ Storage Hierarchy

This item allows you to enable or disable storage hierarchy.

### ■ Endorsement Hierarchy

This item allows you to enable or disable endorsement hierarchy.

- **TPM2.0 UEFI Spec Version**

This item allows you to select the supported TCG version based on your OS.

TCG\_1\_2: Supports Windows 8 /10.

TCG\_2: Supports new TCG2 protocol and event format for Windows 10 or later.

- **Physical Presence Spec Version**

This item allows you to select the physical presence spec version. Select <1.2> or <1.3> version.

- **Device Select**

This item allows you to select the physical presence spec version.

Select <TPM 1.2>, <TPM 1.3>, or <Auto> version.

## 4.3.5 ACPI Settings

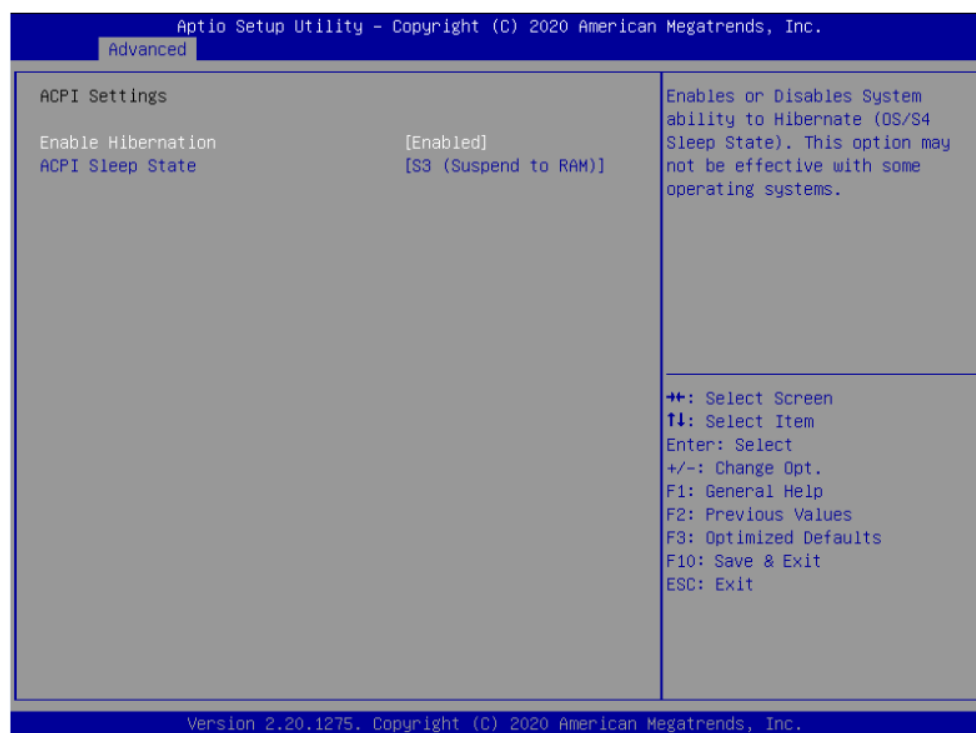

- **Enable Hibernation**

This item allows you to enable or disable system ability to hibernate.

- **ACPI Sleep State**

This item selects the highest ACPI sleep state the system will enter when the suspend button is pressed. Select <Suspend Disabled> or <S3 (Suspend to RAM)>.



## 4.3.6 Super IO Configuration

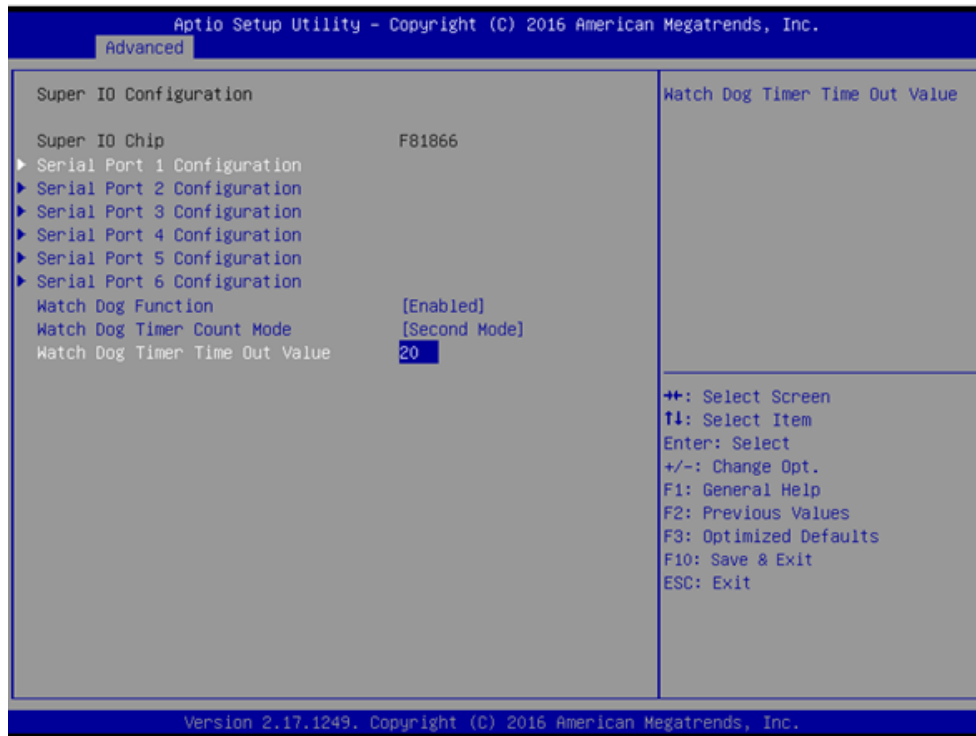

This setting allows you to select options for the Super IO Configuration, and change the value of the selected option.

### ■ Serial Port 1 Configuration

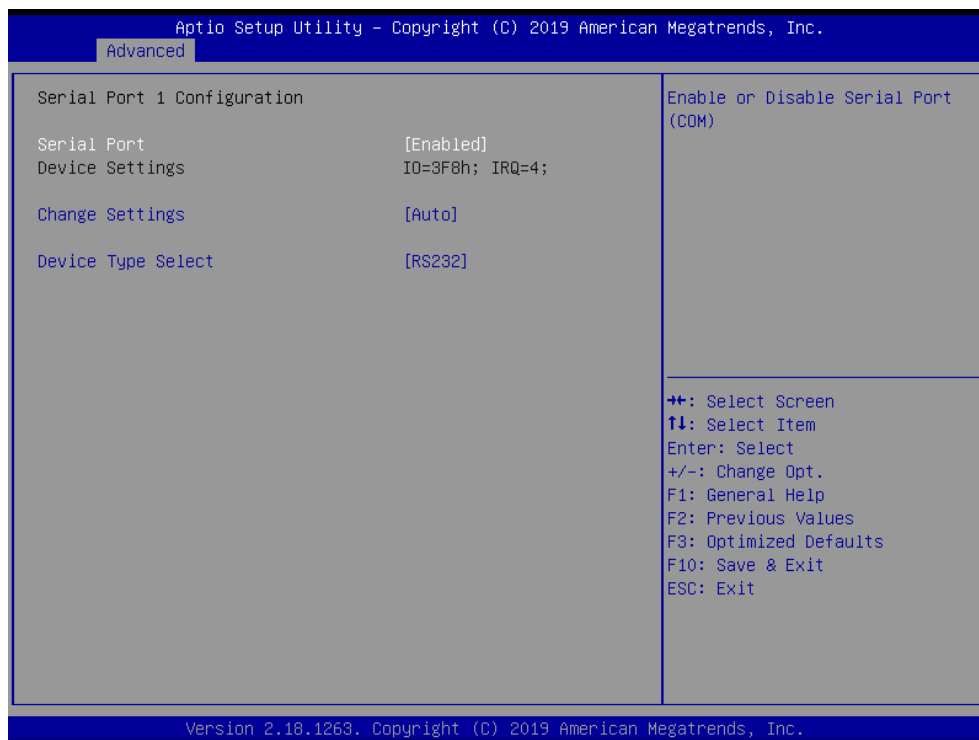

■ Serial Port 2 Configuration

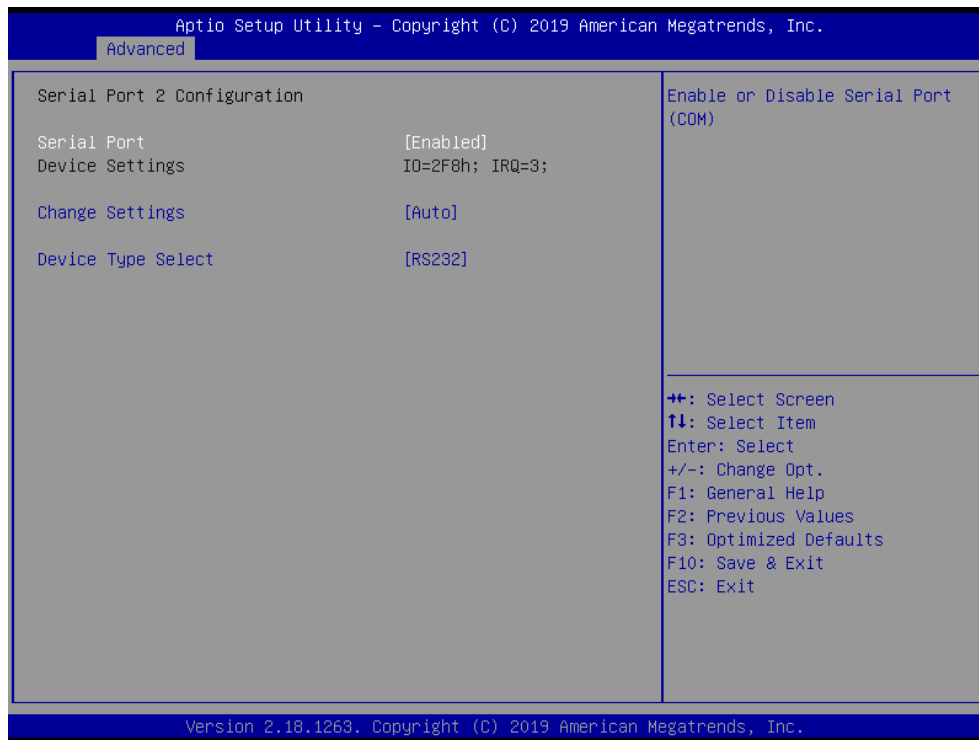

■ Serial Port 3 Configuration

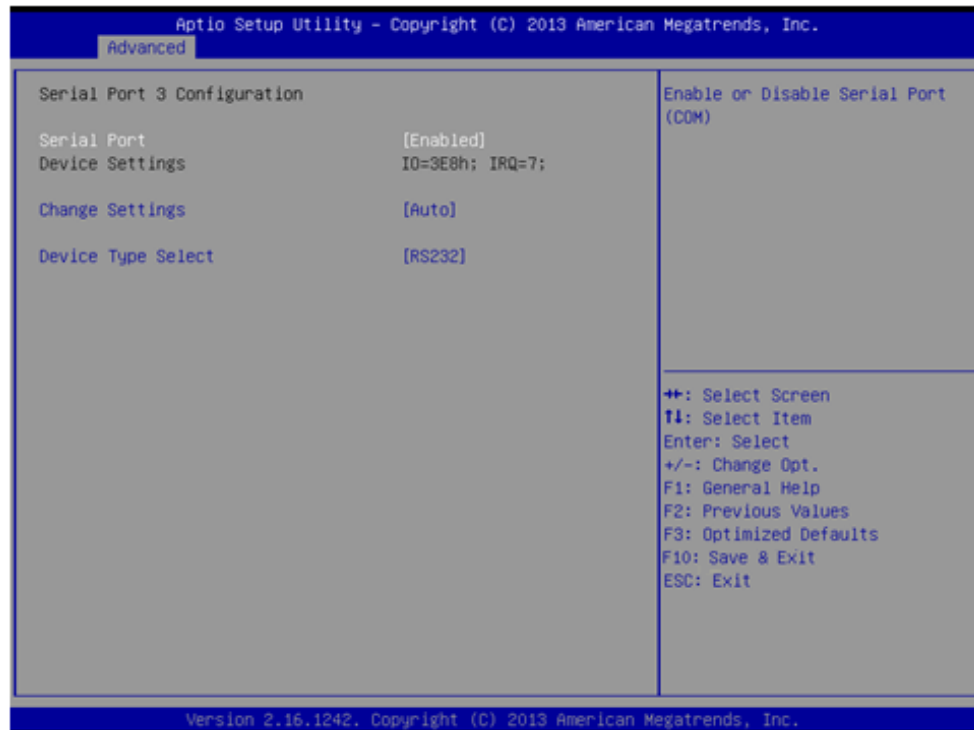

## ■ Serial Port 4 Configuration

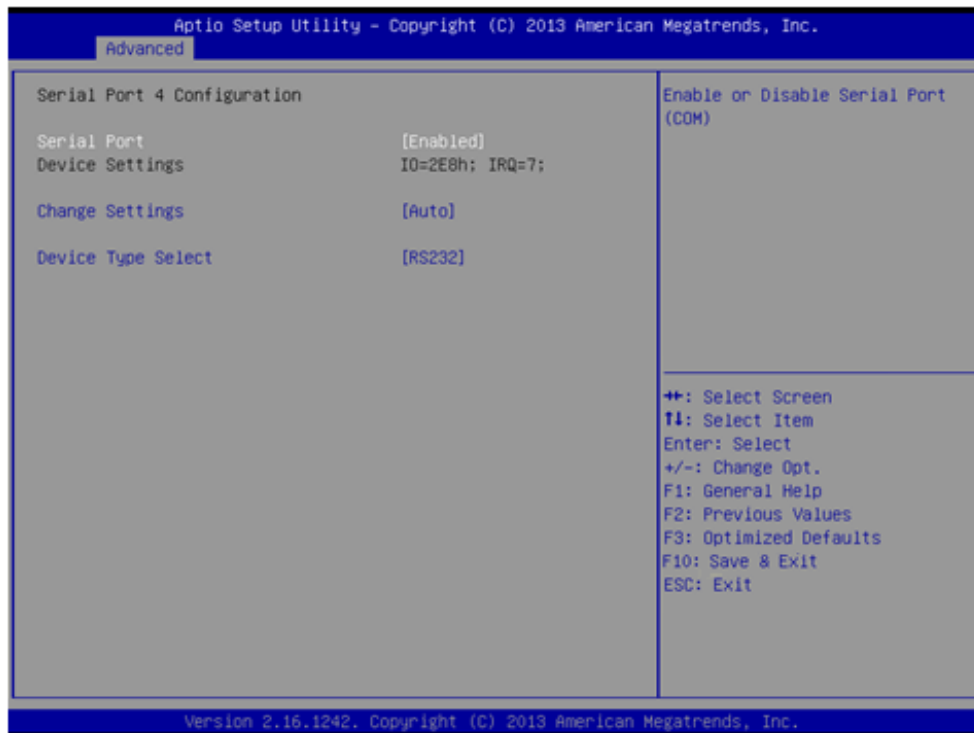

## ■ Serial Port 5 Configuration



## Serial Port 6 Configuration

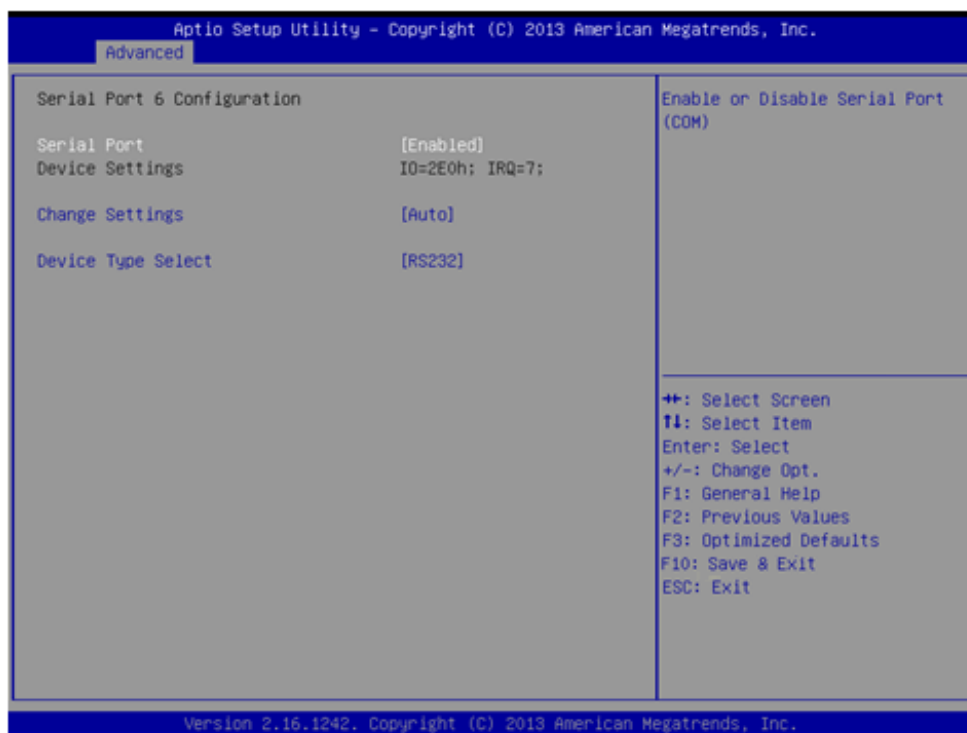

### Serial Port

This item allows you to enable or disable serial port.

### Change Settings

This item allows you to change the address & IRQ settings of the specified serial port.

### Device Type Select

Change the Serial interface.

Select <RS232>, <RS422 Full Duplex>, or <RS485 Half Duplex> interface.

### Watch Dog Function

This setting allows you to set up the system watch-dog timer, a hardware timer that generates a reset when the software that it monitors does not respond as expected.

Watch Dog Mode:

Change the Watch dog mode. Select <SEC> or <MIN> mode.

Watch Dog Timer:

User can set a value in the range of 1 to 255.

### 4.3.7 Serial Port Console Redirection

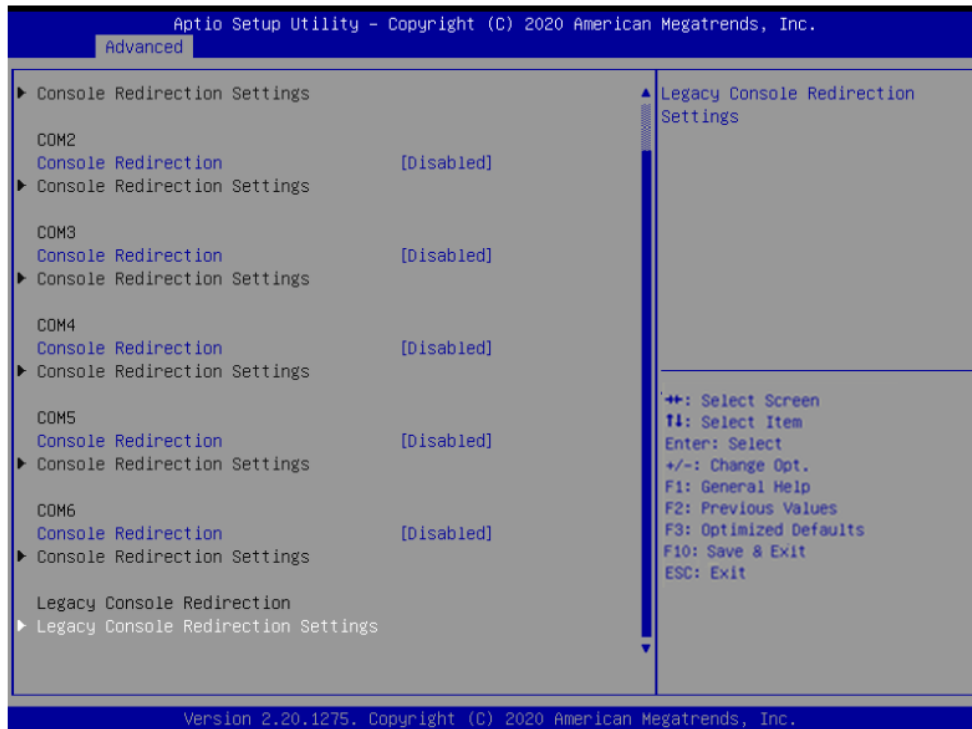

■ **Legacy Console Redirection Settings**

Select a COM port to display redirection of Legacy OS and Legacy OPROM Messages.

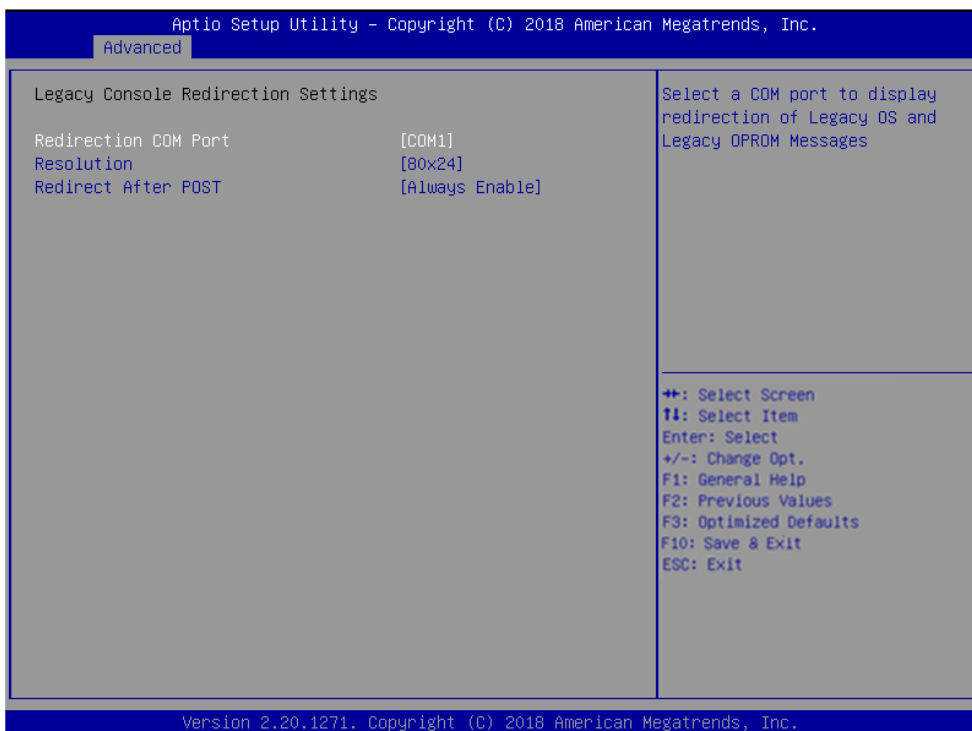

- **Redirection COM Port**

Select a COM port to display redirection of Legacy OS and Legacy OPROM Messages.

- **Resolution**

On Legacy OS, the Number of Rows and Columns supported redirection.

- **Redirect After POST**

When [Bootloader] is selected, Legacy Console Redirection is disabled before booting to legacy OS. When [Always Enable] is selected, Legacy Console Redirection is enabled for legacy OS.



## 4.3.8 Hardware Monitor

These items display the current status of all monitored hardware devices / components such as voltages and temperatures.

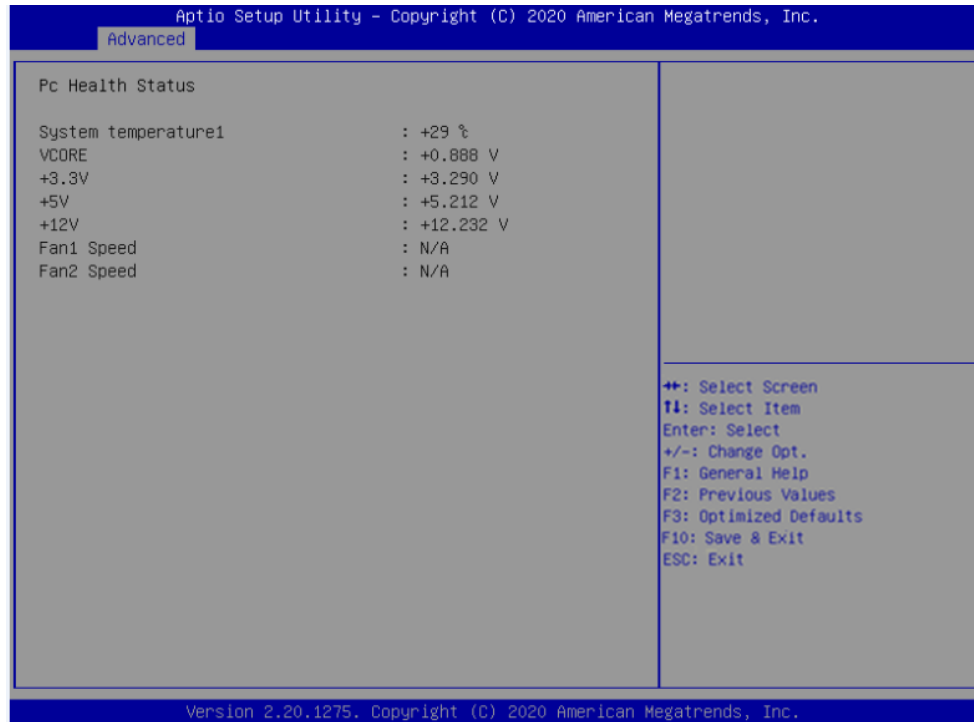

## 4.3.9 USB Configuration

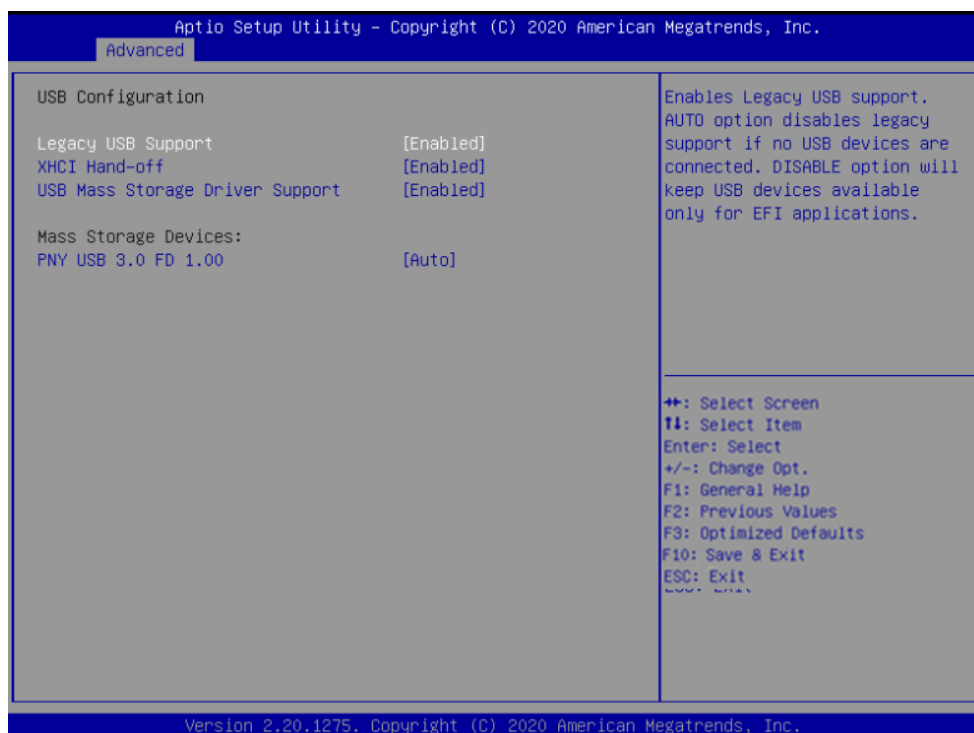

- **Legacy USB Support**  
 This item allows you to enable or disable legacy USB Support.  
 [Enabled]: Allows USB keyboard/ mouse to be used in MS-DOS.  
 [Disabled]: Keeps USB devices available only for EFI applications.  
 [Auto]: Disables legacy support if there is no USB device connected.
- **XHCI Hand-off**  
 This is a workaround for OSES without XHCI hand-off support.  
 The XHCI ownership change should be claimed by XHCI driver.
- **USB Mass Storage Driver Support**  
 This item allows you to enable or disable the support for USB mass storage driver.

## 4.3.10 CSM Configuration

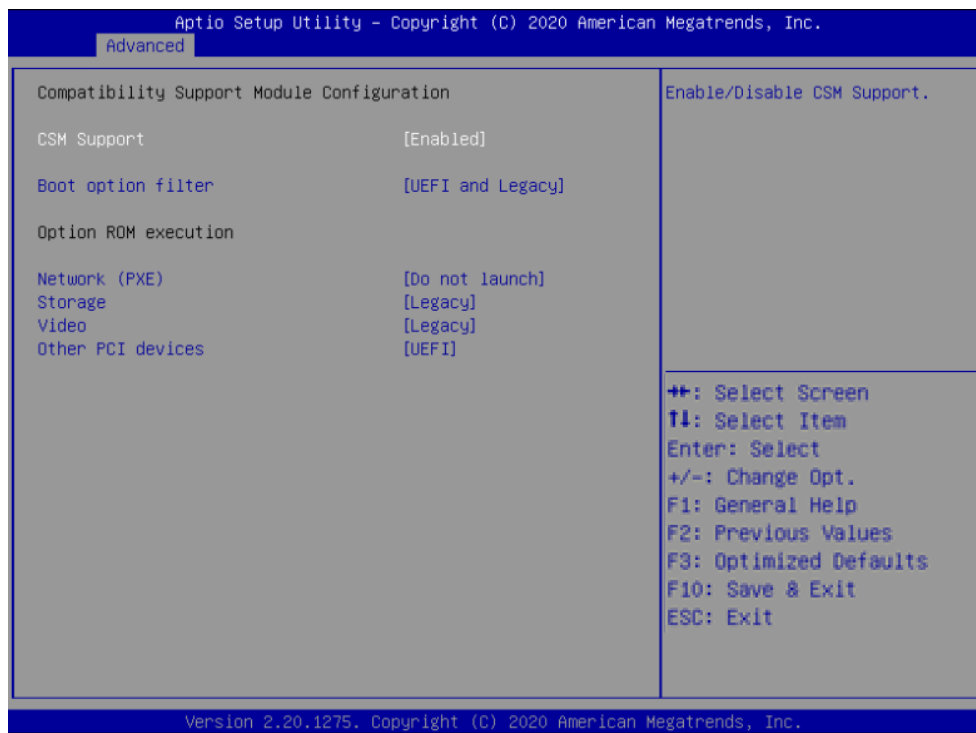

### ■ CSM Support

Enables or disables UEFI CSM (Compatibility Support Module) to support a legacy PC boot process.

### ■ Boot Option Filter

This item allows you to select which type of operating system to boot.

[UEFI and Legacy]: Allows booting from operating systems that support legacy option ROM or UEFI option ROM.

[Legacy only]: Allows booting from operating systems that only support legacy option ROM.

[UEFI only]: Allows booting from operating systems that only support UEFI option ROM.

This item is configurable only when CSM Support is set to Enabled.

### ■ Network (PXE)

Controls the execution of UEFI and Legacy PXE option ROM.

[Do not launch]: Disables option ROM execution.

[Enabled]: Enables legacy option ROM only.

### ■ Storage

This setting allows you to select whether to enable the UEFI or legacy option ROM for the storage device controller.

[Do not launch]: Disables option ROM.

[UEFI only]: Enables UEFI option ROM only.

[Legacy only]: Enables legacy option ROM only.

- **Video**

Controls the execution of UEFI and Legacy Video OpROM.

[Do not launch]: Disables option ROM.

[Do not launch]: Disables option ROM.

[UEFI]: Enables UEFI option ROM only.

[Legacy]: Enables legacy option ROM only.

- **Other PCI devices [Do not launch]**

This item allows you to determine option ROM execution policy for device other than network, storage, or video.

## 4.4 Chipset

This section allows you to configure and improve your system and allows you to set up some system features according to your preference.

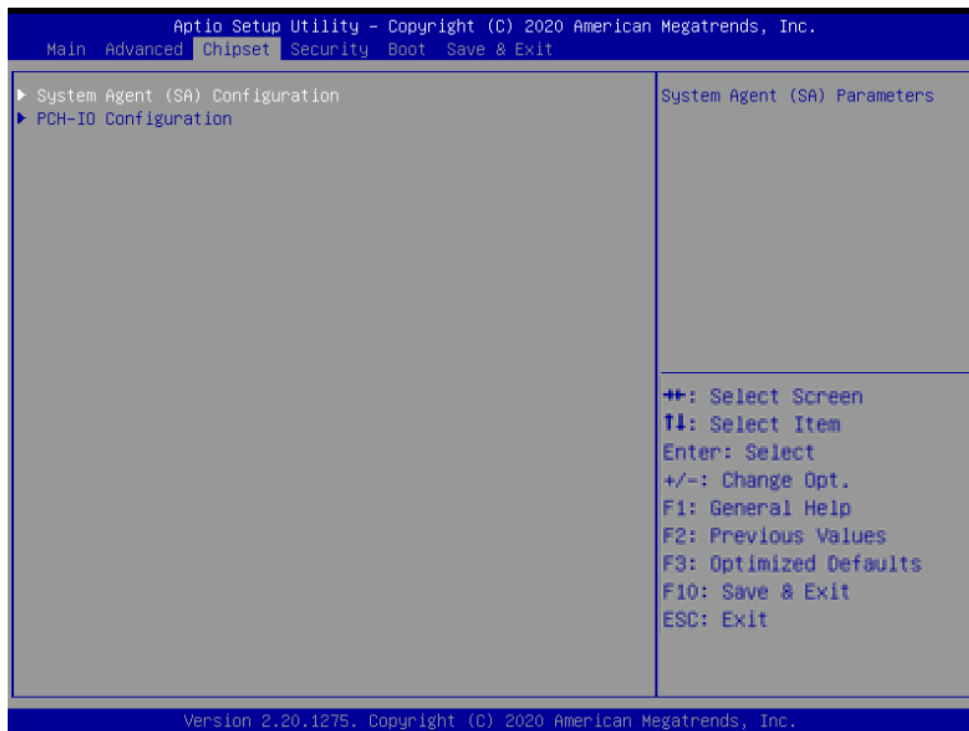

### 4.4.1 System Agent (SA) Configuration

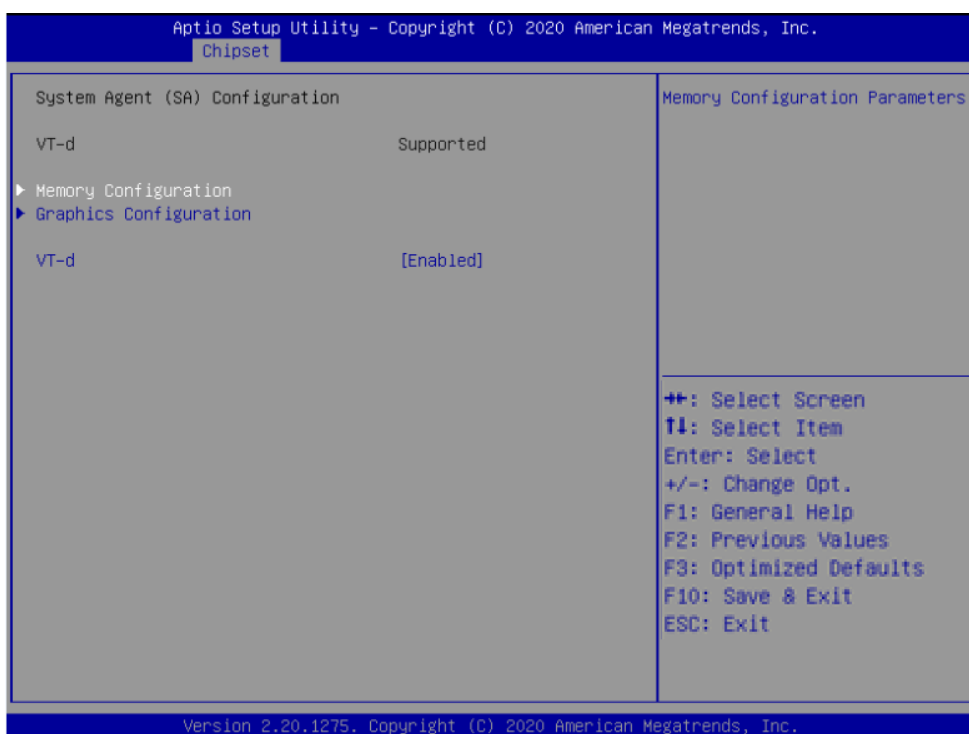

■ **Memory Configuration**

This item displays detailed memory configuration in the system.



■ **Max TOLUD**

Maximum Value of TOLUD. Dynamic assignment would adjust TOLUD automatically based on largest MMIO length of installed graphic controller. Select <Dynamic>, <1 GB>, <1.25 GB>, <1.5 GB>, <1.75 GB>, <2GB>, <2.25GB>, <2.5GB>, <2.75GB>, <3GB>, <3.25GB>, <3.5GB> memory.

■ **Graphics Configuration**

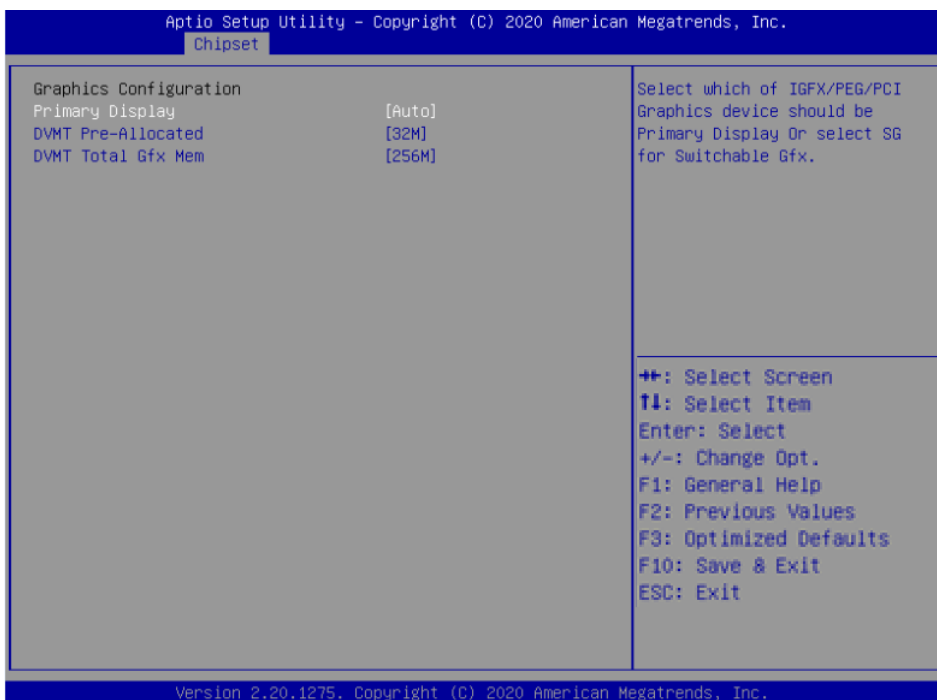



- **Primary Display**  
Select which of IGFX/ PEG/ PCI Graphics device should be Primary Display or select SG for Switchable Gfx. Select <Auto>, <IGFX>, <PEG>, <PCI> or <SG> interface.
- **DVMT Pre-Allocated**  
DVMT pre-allocated (fixed) Graphics memory size optimal from 32M to 1024M.
- **DVMT Total Gfx Mem**  
DVMT Total Gfx Mem optimal Between 128M, 256M, or MAX.
- **VT-d [Enabled]**  
This item allows users to enable or disable Intel® Virtualization Technology for Directed I/O (VT-d) capability.

## 4.4.2 PCH-IO Configuration

This section allows you to configure the chipset.



### ■ PCI Express Configuration

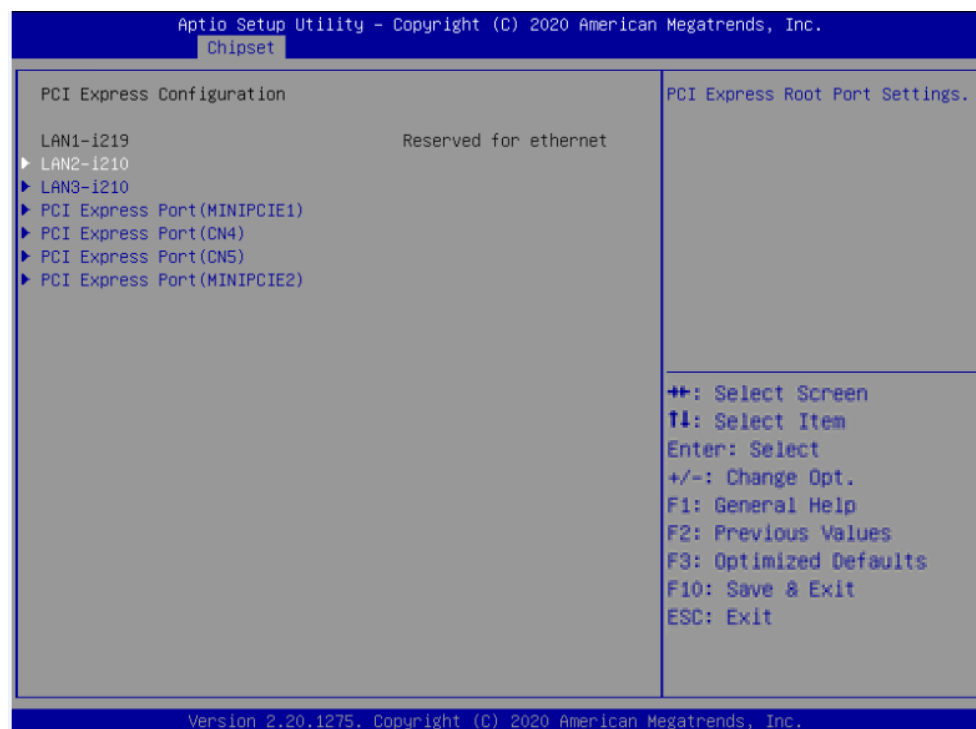

- **LAN2-I210**  
This item allows you to enable or disable LAN2 in the chipset.  
Speed:  
Change the PCIe Port Speed. Select <AUTO> ,<Gen 1> ,<Gen 2> , or <Gen 3>
- **LAN3-I210**  
This item allows you to enable or disable LAN3 in the chipset.  
Speed:  
Change the PCIe Port Speed. Select <AUTO> ,<Gen 1> ,<Gen 2> , or <Gen 3>
- **PCI Express Port (MINIPCIE1)**  
This item allows you to enable or disable MINIPCIE1 in the chipset.  
Speed:  
Change the PCIe Port Speed. Select <AUTO> ,<Gen 1> ,<Gen 2> , or <Gen 3>
- **PCI Express Port (CN4)**  
This item allows you to enable or disable LAN3 in the chipset.  
Speed:  
Change the PCIe Port Speed. Select <AUTO> ,<Gen 1> ,<Gen 2> , or <Gen 3>
- **PCI Express Port (CN5)**  
This item allows you to enable or disable LAN3 in the chipset.  
Speed:  
Change the PCIe Port Speed. Select <AUTO> ,<Gen 1> ,<Gen 2> , or <Gen 3>
- **PCI Express Port (MINIPCIE1)**  
This item allows you to enable or disable MINIPCIE2 in the chipset.  
Speed:  
Change the PCIe Port Speed. Select <AUTO> ,<Gen 1> ,<Gen 2> , or <Gen 3>

## ■ HD Audio Configuration



### ■ HD Audio

Control detection of the HD-Audio device. This item allows you to select <Enabled>, <Disabled>, or <Auto>.

Disabled: HD-Audio will be unconditionally be disabled.

Enabled: HD-Audio will be unconditionally be enabled.

Auto: HD-Audio will be enabled if present, disabled otherwise.

### ■ Wake on LAN

This item allows you to enable or disable wake on LAN function.

## 4.5 Security

The security menu allows you to change administrator password and user password settings.

- **Administrator Password**  
This item allows you to set Administrator Password.
  
- **User Password**  
This item allows you to set User Password.

## 4.6 Boot

This menu allows you to set up the system boot options.

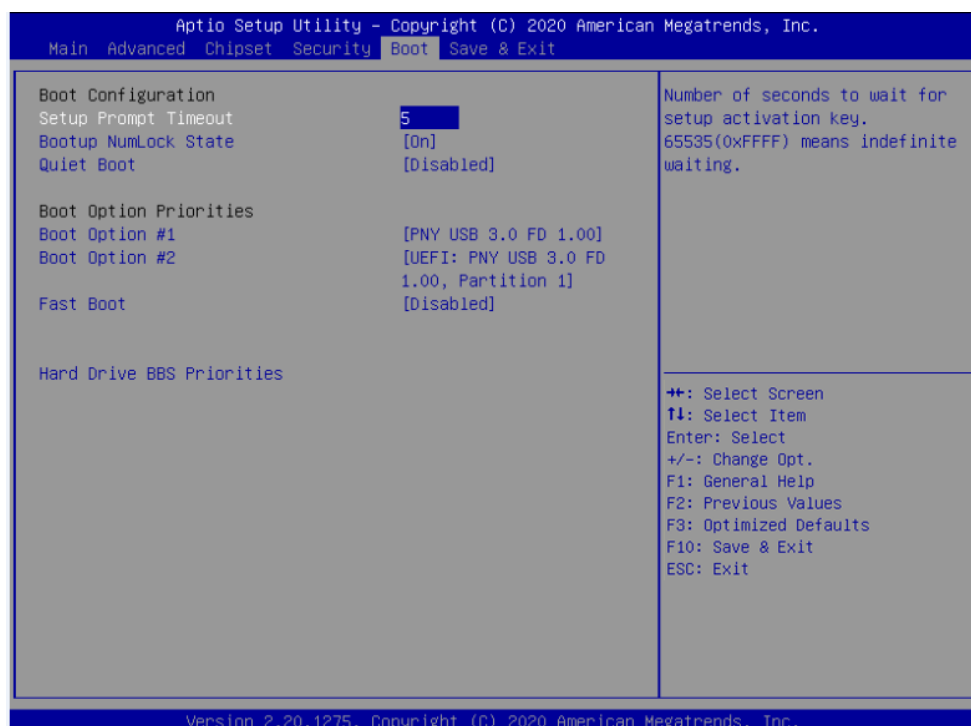

- **Setup Prompt Timeout**  
This item sets number of seconds to wait for setup activation key.
- **Bootup NumLock State**  
This item selects the keyboard NumLock state. Select <On> or <Off> mode.
- **Quiet Boot**  
This item allows you to enable or disable Quiet Boot function.
- **Boot Option Priorities**  
The items specify the boot device priority sequence from the available devices. The number of device items that appears on the screen depends on the number of devices installed in the system.
- **Fast Boot**  
This item allows you to enable or disable Fast Boot function.



## 4.7 Save & Exit

This setting allows you to configure the boot settings.

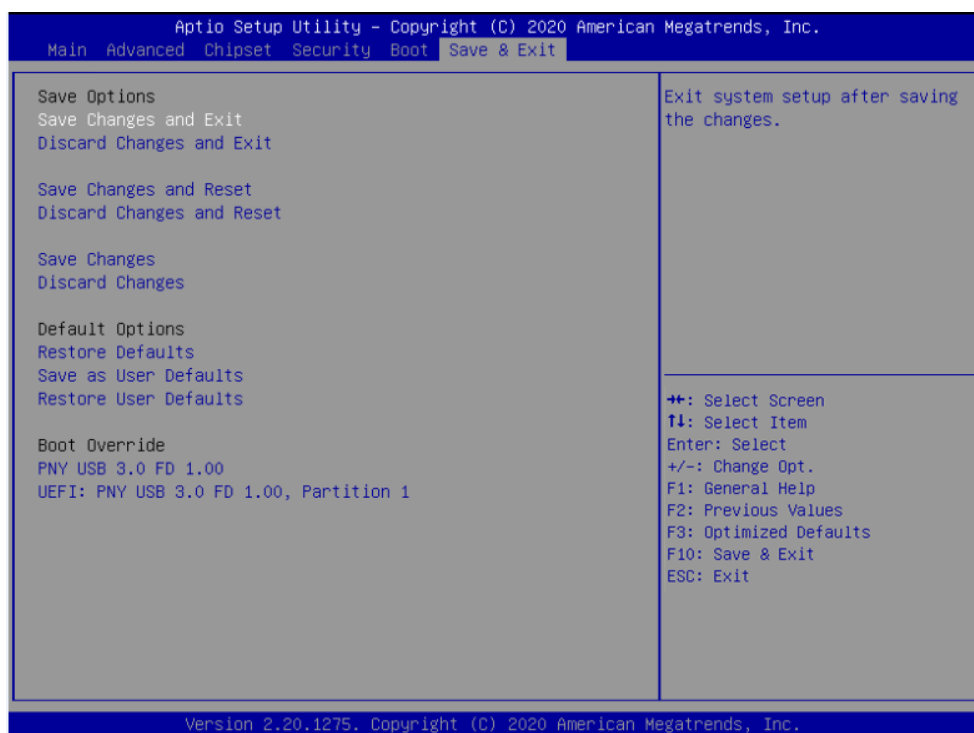

- **Save Changes and Exit**  
This item allows you to exit the system after saving the changes.
- **Discard Changes and Exit**  
This item allows you to reset the system setup without saving any changes.
- **Save Changes and Reset**  
This item allows you reset the system after saving the changes.
- **Discard Changes and Reset**  
This item allows you to reset the system setup without saving any changes.
- **Save Changes**  
This item allows you to save changes done so far to any of the setup options.
- **Discard Changes**  
This item allows you to discard changes done so far to any of the setup options.
- **Restore Defaults**  
This item allows you to restore/ load default values for all the setup options.

- **Save as User Defaults**

This item allows you to save the changes done so far as user defaults.

- **Restore User Defaults**

This item allows you to restore the user defaults to all the setup options.